

PRELIMINARY DATA SHEET

**SDA 9489X PIP IV Advanced
SDA 9589X SOPHISTICUS
High-End
Picture-In-Picture ICs**

High-end Picture-In-Picture (PIP) ICs

Version 1.3

CMOS

General Description

SDA 9489X 'PIP IV Advanced' and SDA 9589X 'SOPHISTICUS' belong to a new generation of Picture-in-Picture (PiP) processors that combine high-quality digital PIP signal processing, digital multistandard color decoding and AD/DA conversion on a single chip. Both devices are equipped with CVBS and Y/C input interfaces. In addition the SDA SDA 9589X is also able to process YUV input signals for displaying high quality video signals e.g. coming from a DVD source.

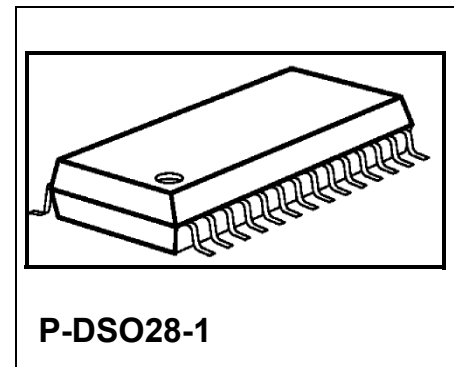


Figure 0-1 Picture-In-Picture

The integrated digital color decoder is able to decode all analog TV standards (PAL, NTSC and SECAM) and detects the standard automatically. Therefore the IC is suited for world-wide use.

A picture reduction from 1/4 to 1/81 of original size selectable in fine steps is possible. The transfer functions of the decimation filters are optimally matched to the selected picture size reduction and can furthermore be adjusted to the viewer's requirements by a selectable peaking. A maximum of 324 luminance and 2x81 chrominance pixels per line are stored in the memory. The PiP supports split-screen applications as well as multi-PiP display.

Type	Package
SDA 9489X	P-DSO28-1
SDA 9589X	P-DSO28-1

1	Features	5
2	Pin Configuration	7
3	Block Diagram	9
4	System Description	10
4.1	Analog Frontend	10
4.1.1	Input Selection	10
4.1.2	AD-Conversion	10
4.1.3	Automatic Gain Control	11
4.1.4	Signal Magnitudes	11
4.2	Inset Synchronization	13
4.3	Chroma Decoding And Standard Identification	13
4.4	Comb Filtering	15
4.5	Luminance Processing	15
4.6	Decimation	16
4.6.1	Single PIP Mode	16
4.6.2	Continuos Zoom	17
4.6.3	Horizontal And Vertical Fine Positioning	19
4.6.4	Multi Display Mode	20
4.6.5	Split Screen	20
4.6.6	Multi-PiP Mode	21
4.7	Display Control	22
4.7.1	100 Hz Frame Mode	25
4.7.2	Mixed Standard Applications And (S)VGA Support	26
4.7.3	Display standard	27
4.7.4	Picture Positioning	28
4.7.5	Wipe In / Wipe Out	29
4.8	Output Signal Processing	30
4.8.1	Luminance Peaking	30
4.8.2	RGB Matrix	31
4.8.3	Frame Generation And Colored Background	32
4.8.4	16:9 Inset Picture Support	33
4.8.5	Parent Clock Generation	33
4.8.6	Select Signal	34
4.8.7	Automatic Brightness Reduction	34
4.9	On Screen Display (OSD)	35
4.9.1	Display Format	35
4.9.2	Character Programming	35
4.9.3	Character and Character Background Color	36
4.10	DA-Conversion And RGB / YUV Switch	36
4.10.1	Pedestal Level Adjustment	37
4.10.2	Contrast, Brightness and Peak Level Adjustment	38

4.11	Data Slicer	39
4.11.1	Closed Caption	39
4.11.2	Widescreen Signalling (WSS)	39
4.11.3	Indication Of New Data	39
4.11.4	Violence Protection	40
5	Application Examples	41
6	I2C Bus	42
6.1	I2C Bus Address	42
6.2	I2C-Bus Format	42
6.3	I2C bus Command Table	43
6.4	I2C Bus Command Description	45
7	Pin Description	78
8	Absolute Maximum Ratings	81
9	Recommended Operating Range	82
10	Characteristics	86
11	Diagrams	90
12	Application Circuit	100

1 Features

- Single chip solution:
 - AD-conversion for CVBS or Y/C or YUV¹⁾, multistandard color decoding, PLL for synchronization of inset channel, decimation filtering, embedded memory, RGB-matrix, DA-conversion, RGB/YUV switch, data-slicer and clock generation integrated on chip
- Analog inputs:
 - 3x CVBS or 1x CVBS and 1x Y/C or 1xYUV¹⁾alternatively
 - Clamping of each input
 - All ADCs with 8 bit amplitude resolution
 - Automatic Gain Control (AGC) for Y and CVBS
- Inset Synchronization:
 - Multiple time constants for reliable synchronization
 - Automatic recognition of 625 lines / 525 lines standard
- Color Decoder:
 - PAL-B/G, PAL-M, PAL-N(Argentina), PAL60, NTSC-M, NTSC4.4 and SECAM
 - Adjustable color saturation
 - Hue control for NTSC
 - Automatic Chroma Control (-24 dB ... +6 dB)
 - Automatic recognition of chroma standards: different search strategies selectable
 - Single crystal for all standards
 - IF-characteristic compensation filter
- Decimation:
 - PIP sizes between 1/81 and 1/4 adjustable with steps of 2 lines and 4 pixel
 - Resolution up to 324 luminance and 2x81 chrominance pixels per inset line
 - Horizontal and vertical filtering dependent on picture size
 - Automatic zoom in/out possible with three speeds
- Display Features:
 - 7 bit per pixel stored in memory
 - Field and joint-line free frame mode display (even at 100/120 Hz AABB with picture sizes \leq 1/9)
 - Two 'split-screen' modes with horizontal decimation of 2 and vertical of 1.5 or 1.0
 - POP display
 - Up to 12 pictures of 1/36th size (11 still and 1 moving)
 - Up to 6 pictures of 1/16th size (5 still and 1 moving)
 - Up to 3 pictures of 1/9th size (2 still and 1 moving)
 - Display on VGA and SVGA screen (f_H limited to 40kHz)
 - 8 different read frequencies for 16:9 compatibility
 - Line doubling mode for progressive scan applications

¹⁾ SDA 9589X only

Features

- Freeze picture
- Coarse positioning at 4 corners of the parent picture
- Fine positioning at steps of 4 pixels and 2 lines
- Wipe in / out programmable with 3 time periods
- Output signal processing:
 - 7 Bit DAC
 - RGB or YUV switch: insertion of an external source without PIP processing
 - Digital interpolation for anti-imaging
 - Adjustable transient improvement for luma (peaking)
 - Contrast, Brightness and Pedestal Level adjustable
 - Analog outputs: Y, +(B-Y), +(R-Y), or Y, -(B-Y), -(R-Y) or RGB
 - Three RGB matrices available: NTSC(Japan), NTSC(USA) or EBU
 - 64 different background colors and 4096 different frame colors
 - Plain or 3D frame with variable width and height
- Data Slicing:
 - Slicing of closed-caption (CC) or wide-screen-signaling (WSS) data
 - Violence blocking capability (V-chip)
 - Several filter for XDS data extraction
- On-screen display:
 - 64 characters programmable
 - 5 characters displayed in every PIP picture or 3 rows of 20 characters each
 - 4 different character luminance values or frame color
 - 4 background luminance values or (semi-) transparent mode
- I²C-Bus control (400 kHz)
- High stability clock generation
- PDSO 28-1 package (SMD)
- Full SDA 9488X and SDA 9588X backward compatibility
- SDA 9388X / SDA 9389X pinout compatibility
- 3.3V supply voltage (5V input capable)

2 Pin Configuration

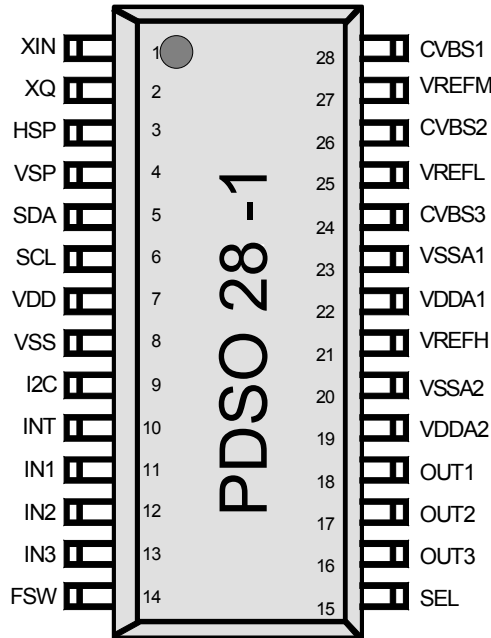
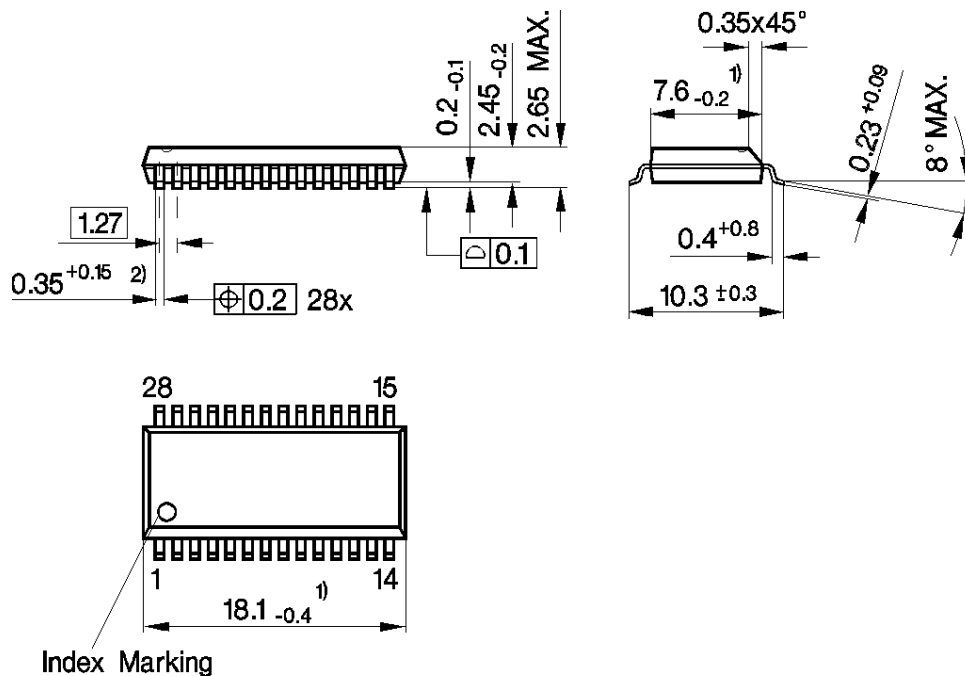


Figure 2-1 Pinning



- 1) Does not include plastic or metal protrusion of 0.15 max. per side
- 2) Does not include dambar protrusion of 0.05 max. per side

Figure 2-2 Package Outlines

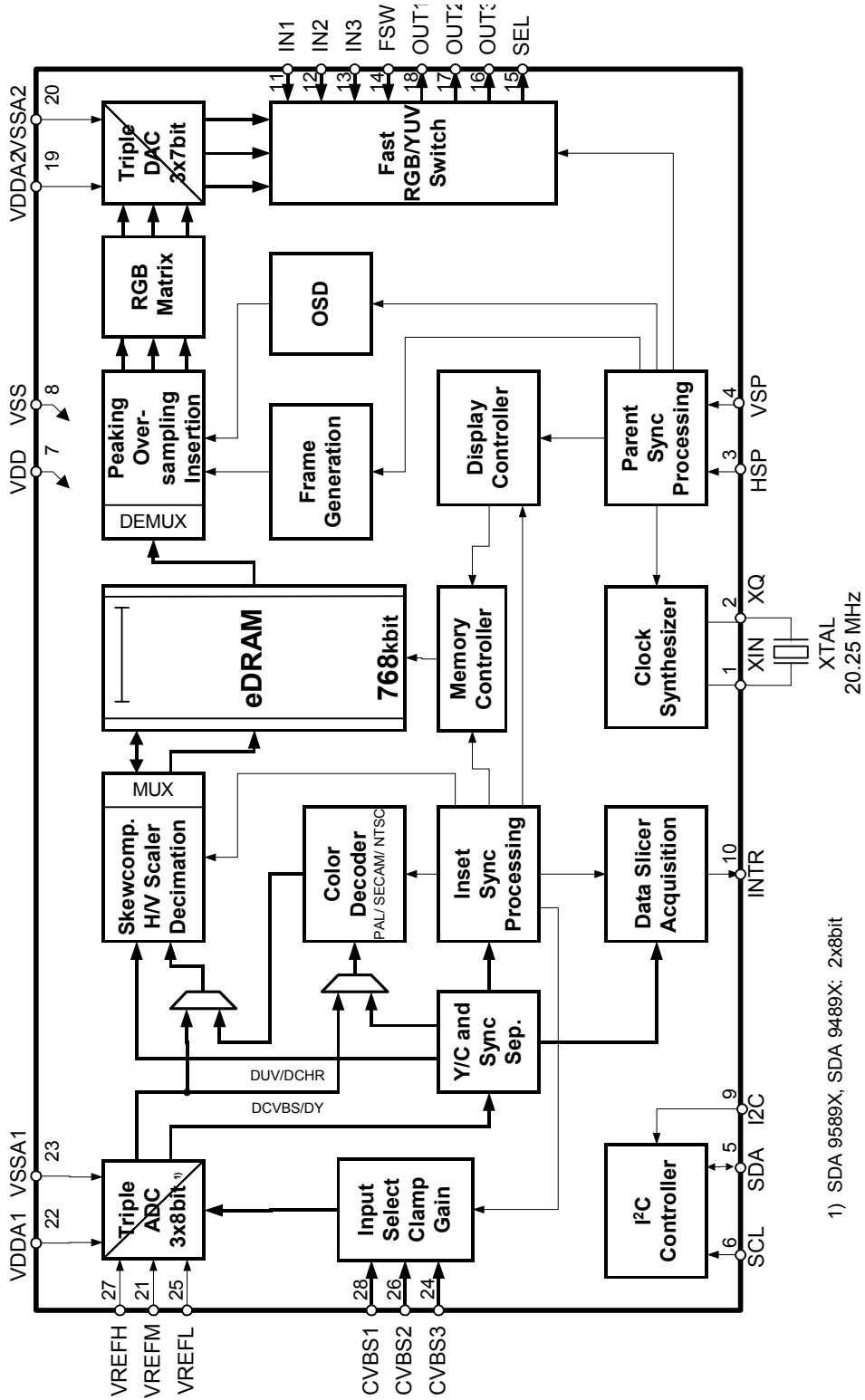
Pin Configuration

Number	Name	Type	Description
1	XIN	I	crystal oscillator (input) or external clock input
2	XQ	O	crystal oscillator (output)
3	HSP	I/TTL	horizontal sync for parent channel
4	VSP	I/TTL	vertical sync for parent channel
5	SDA	I/O	I ² C-bus data
6	SCL	I	I ² C-bus clock
7	VDD	S	digital supply voltage
8	VSS	S	digital ground
9	I2C	I	I ² C Address
10	INT	O/TTL	interrupt
11	IN1	I/ana	V/R input for external YUV/RGB source
12	IN2	I/ana	Y/G input for external YUV/RGB source
13	IN3	I/ana	U/B input for external YUV/RGB source
14	FSW	I	fast switch input for YUV/RGB switch
15	SEL	O	fast blanking output for PIP
16	OUT3	O/ana	analog output: chrominance signal +(B-Y) or -(B-Y) or B
17	OUT2	O/ana	analog output: luminance signal Y or G
18	OUT1	O/ana	analog output: chrominance signal +(R-Y) or -(R-Y) or R
19	VDDA2	S	analog supply voltage for DAC
20	VSSA2	S	analog ground for DAC
21	VREFH	I/ana	upper reference voltage for ADC and DAC
22	VDDA1	S	analog supply voltage for ADC
23	VSSA1	S	analog ground for ADC
24	CVBS3	I/ana	CVBS3 or V (SDA 9589X) or C Input
25	VREFL	I/O	lower reference voltage for ADC
26	CVBS2	I/ana	CVBS2 or U (SDA 9589X) or Y (from Y/C) Input
27	VREFM	I/O	mid-level reference voltage for ADC
28	CVBS1	I/ana	CVBS1 or Y (from YUV, SDA 9589X) Input
I= Input / ana=analog / O= Output / TTL=Digital (TTL) / S=Supply voltage			

Table 2-1 Pin Description

Block Diagram

3 Block Diagram



1) SDA 9589X, SDA 9489X: 2x8bit

Figure 3-1 Block Diagram

4 System Description

4.1 Analog Frontend

4.1.1 Input Selection

An analog inset CVBS signal can be fed to the inputs CVBS1-3 of SDA 9589X/SDA 9489X. Each of these sources is selectable via I²C bus (**CVBSEL**). CVBS2 and CVBS3 can be used as separate Y/C inputs. At SDA 9589X YUV sources can be connected to CVBS1, CVBS2 and CVBS3 provided YUV operation being enabled (**YUVSEL**). Using an external switch SDA 9589X can operate in applications with both YUV and CVBS signals.

CVBSEL		YUVSEL	Input			remark
D1	D0		CVBS1	CVBS2	CVBS3	
0	0	0	CVBS			
0	1	0		CVBS		
1	0	0		Y (VBS)	C	Y/C mode
1	1	0			CVBS	
X	X	1	Y (VBS)	U (CB)	V (CR)	YUV mode (only SDA 9589X)

Table 4-1 Input selection

4.1.2 AD-Conversion

All signal are clamped and AD-converted with an amplitude resolution of 8bit. CVBS and Y signals are clamped to the sync bottom whereas U/V and C signals are clamped to their mid-level during blanking.

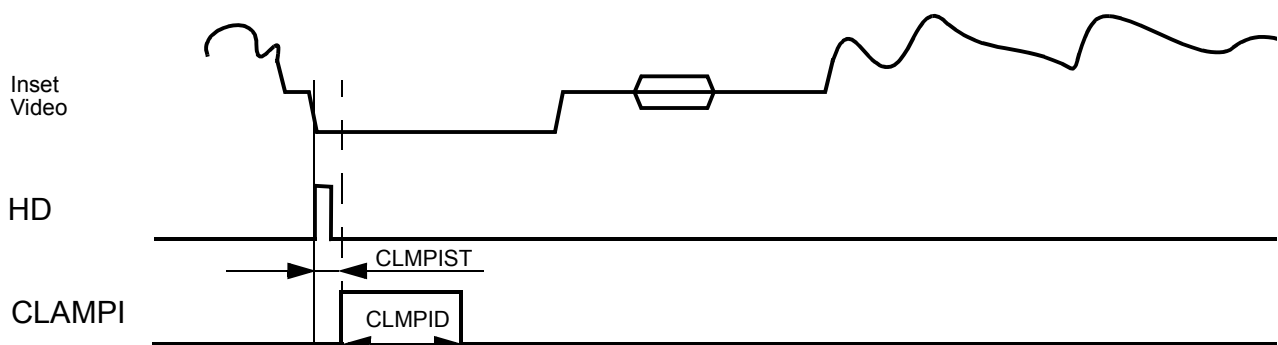


Figure 4-1 Clamping timing

System Description

The clamping pulse can be shifted in position (**CLMPIST**) and length (**CLMPID**) to adjust to the specific application. The ADCs are driven by a 20.25 MHz free running crystal clock which is not related to the incoming CVBS signal.

To avoid aliasing by subsampling the CVBS signal and the Y/C signals should be band-limited to 10MHz. In the same manner the U/V signal frequency spectrum should not exceed 5 MHz. The digital filtering suppresses all frequencies above the usable spectrum.

4.1.3 Automatic Gain Control

To accommodate to different CVBS input voltages an automatic gain control has been implemented. The chip works correctly for input voltages in the range from 0.5 to $1.5V_{pp}$. For best signal-to-noise ratio, the maximum CVBS amplitude is recommended if available. The AGC behavior can be chosen out of four possibilities (**AGCMDE**).

The sync height serves as reference for the gain control in the typical application. When using overflow detection only, the gain is set to maximum and is reduced whenever an overflow occurs. This procedure will be executed again when a channel change is detected or the gain control is manually reset by **AGCRES**.

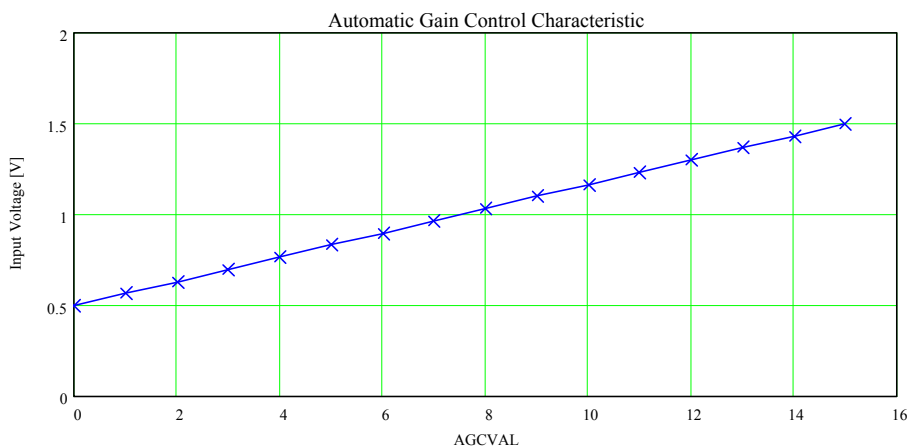


Figure 4-2 AGC characteristic

4.1.4 Signal Magnitudes

The nominal CVBS signal with 75% color has a magnitude of $1V_{pp}$. The upper headroom is left to permit signals with 100% color resulting in $1.23V_{pp}$. The Y signal must always contain the sync part. Its levels correspond to the CVBS levels except for the missing color and burst. After A/D conversion the video part is clamped to its black value and is amplified to 224 digital steps. The nominal signal levels ensure correct brightness and saturation. The YUV signal levels conform to the ITU 601 recommendation.

System Description

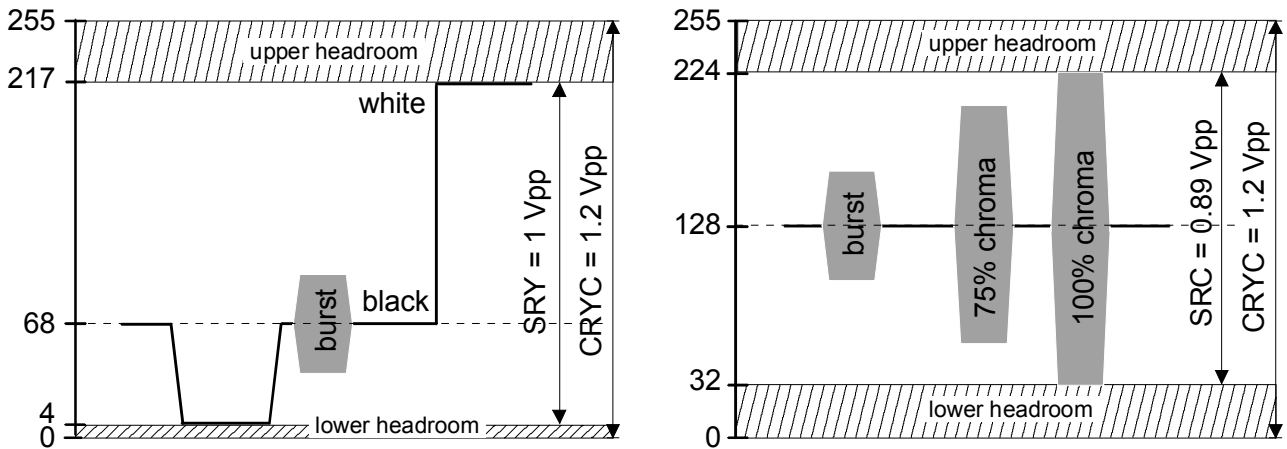


Figure 4-3 CVBS/Y and chroma ADC input signal range

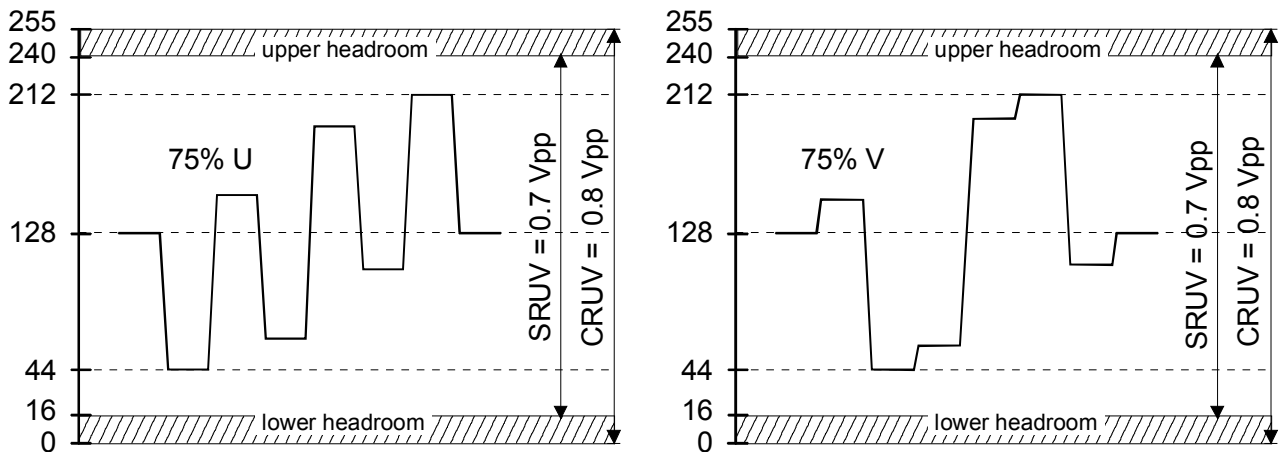


Figure 4-4 UV input signal range

AGCVAL				Conversion Range CRYC	Signal Range SRY	Signal Range SRC	Conversion Range CRUV	Signal Range SRUV
D3	D2	D1	D0					
0	0	0	0	0.5V _{pp}	0.42V _{pp}			
					
1	0	0	0	1.2V _{pp}	1.0V _{pp}	0.89V _{pp}	0.8V _{pp}	0.7V _{pp}
					
1	1	1	1	1.5V _{pp}	1.25V _{pp}			

Table 4-2 ADC conversion range and required input signal voltage

System Description
4.2 Inset Synchronization

Horizontal and vertical sync pulses are separated after elimination of the high frequency components of the CVBS signal by a low pass filter. Horizontal sync pulses are generated by a digital phase-locked-loop (DPLL). Its time constant is adjustable between fast and slow behavior in four steps (**PLLITC**) to consider different input sources (e.g. VCR). Noisy input signals become more stable when a noise-reduction is enabled (**NSRED**). Additionally weak input signals from a satellite dish ('fishes') become more stable when **SATNR** is enabled. Both should be enabled to have best available performance. When **NOSIGB** is enabled, a colored background is shown instead of the picture when PIP is out of synchronization. The detected line standard is indicated by **SYNCSTAT**.

4.3 Chroma Decoding And Standard Identification

The system is able to decode NTSC and PAL signals with a subcarrier of 3.58MHz and 4.43MHz (PAL B/M/N/60, NTSC M/4.4) as well as SECAM signals with 4.05/4.2MHz subcarrier. The system may be forced to a certain standard, or an automatic standard detection can be used (**CSTAND**). For automatic standard detection, some standards which are not likely to be received can be ignored to improve the detection process.

Depending on the detected line standard (525 or 625 lines) the color standard detection circuit searches for 60 Hz signals (NTSC-M / PAL-M / PAL 60 / NTSC44) or 50 Hz signals (PAL-B / SECAM / PAL-N) respectively. Within each line standard, the standard is detected by consequently switching from one to another. This standard detection process can be set to medium or fast behavior (**LOCKSP**). In medium behavior 30 fields (in fast 20) are used to detect the standard. If not being successful within this time period the system tries to detect another one. For SECAM detection, a choice between two recognition levels is possible (**SCMIDL**) and the evaluated burst position is selectable (**BGPOS**).

CSTANDEX		NTSC-M	PAL60	PAL-N	PAL-M	PAL-B	SECAM	NTSC 44
D1	D0							
0	0							
0	1							
1	0							
1	1							

Table 4-3 Considered color standards for automatic standard detection

For getting the chrominance information the digitized video signal is multiplied with the regenerated color subcarrier once in-phase and once phase-shifted by 90°. After lowpass filtering digital UV is available for PAL and NTSC. The subcarrier is regenerated

System Description

by a digital PLL. At SECAM operation the PLL runs free and generates the line-wise alternating subcarriers. A CORDIC structure demodulates the frequency-modulated UV signals. The following SECAM de-emphasis filter characteristic is adjustable (**DEEMP**).

The chroma signal can be filtered before demodulation by means of a selectable IF-prefilter (**IFCOMP**).

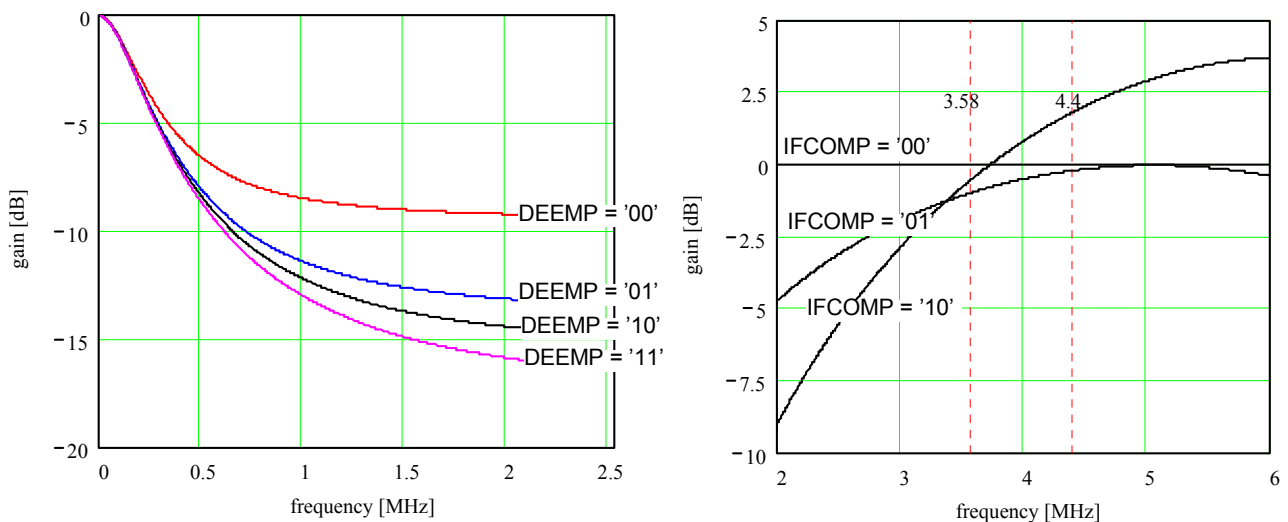


Figure 4-5 SECAM de-emphasis filter characteristic and IF-compensation filter characteristic

The Hue Control (**HUE**) influences the phase of the demodulation subcarrier between -44.8° and 43.4° in steps of 1.4° . This is provided for NTSC only and adjustment is ineffective for PAL and SECAM signals.

The reference for the subcarrier generation is a crystal stable clock of 20.25000 MHz. In order to avoid color standard detection problems, the maximum deviation of this frequency should not exceed 100ppm. For a good PLL locking behavior a maximum deviation of 40ppm is recommended. A small frequency adjustment (-150 ... +310 ppm) is possible for using a crystal with small frequency deviations (**SCADJ**). For test purposes, **CPLL** allows to open the loop of the chroma PLL.

For deviations in the chroma signal up to 30dB, a stable output amplitude after chroma decoding is achieved due to the ACC (Automatic Chroma Control). If the chroma signal (color burst) is below a selectable threshold (**CKILL**), the color will be switched off. Alternatively the color-killer can be bypassed and the color can be switched on or off under all conditions (**COLON**). By setting **ACCFIX**, the automatic chroma control is disabled and set to a default value.

System Description

CKILL		COLON	color killed at damping of
D1	D0		
0	0	0	30 dB
0	1	0	18 dB
1	1	0	24 dB
1	1	0	color always off
X	X	1	color always on

Table 4-4 Color-killer adjustment

The bandwidth of the chroma filter is adjustable via **CHRBW**. The bandwidth depends on whether the decoder is in SECAM operation or not. A change in **CHRBW** does not result in a chrominance position shift on the screen.

CKSTAT can be read out and gives information whether the color is switched on or off. **STDET** indicates the detected color standard. Additionally **PALID** signals whether a PAL signal or a NTSC signal is applied.

4.4 Comb Filtering

Depending on the selected picture size and color standard, a comb filtering is performed for luminance and chrominance. A comb filter uses the spectral interleaving of the encoded luminance and chrominance to separate both without cross artifacts. Thus cross-color and cross-luminance are suppressed effectively. For NTSC sources, a comb filtering is performed for all picture sizes. Due to reduced bandwidth in horizontal and vertical direction a strong reduction of cross artifacts can be achieved for PAL signals. The same applies for the luminance signal of SECAM signals.

4.5 Luminance Processing

The A/D-converted CVBS (or Y) signal is digitally clamped to back porch. Depending on the transmitted standard and operational area, an offset between black- and blanking level can be found in the incoming signal ('7.5 IRE'). As for some applications a black offset is not desired, controlling may be done using **LMOFST**. The positive or negative offset is added to the Y signal before scaling.

System Description

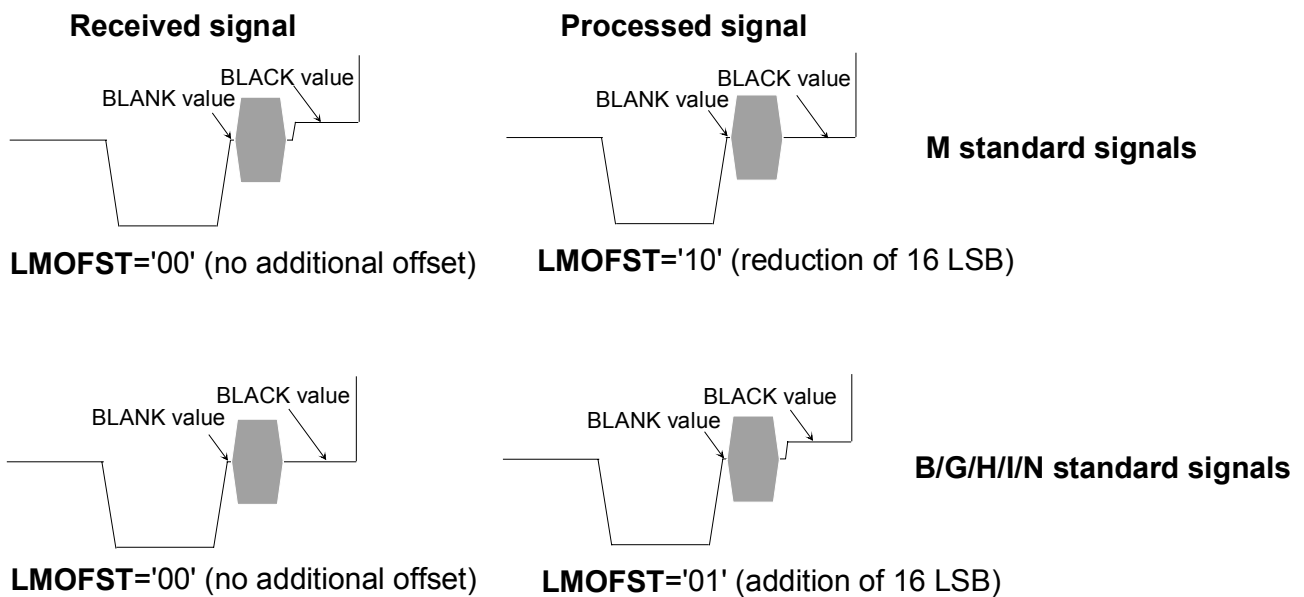


Figure 4-6 Black level correction of luminance signal

The color carrier is removed out of a CVBS signal by means of a notch filter. It is set to the corresponding color carrier (3.58 or 4.4 MHz) only if the standard is detected permanently. This prevents the luminance sharpness of being changed within the standard search process. For Y signals the notch is disabled.

For a fine adjustment of delaycompensation between luminance and chrominance, **YCDEL** allows a luminance shifting in 16 steps of 50ns.

4.6 Decimation

4.6.1 Single PIP Mode

Luminance and chrominance signals are filtered in horizontal and vertical direction. The coarse horizontal and vertical picture size (1/2, 1/3, 1/4, 1/6) is independently programmable with **SIZEHOR** and **SIZEVER**. A fine adjustment in steps of 4 pixel and 2 lines is possible by **HSHRINK** and **VSHRINK**, which allows correct aspect ratio for multistandard applications (50/60 Hz mixed mode, (S)VGA).

For main decimation factors, the stored number of pixel and lines are listed in the following tables.

System Description

SIZEHOR		horizontal scaling	PIP Pixel per line		
D1	D0		Y	(B-Y)	(R-Y)
0	0	2:1	324	81	81
0	1	3:1	216	54	54
1	0	4:1	160	40	40
1	1	6:1	108	27	27

Table 4-5 Number of stored pixel per line dependent on SIZEHOR

SIZEEVER		vertical scaling	PIP lines	
D1	D0		625 lines source	525 lines source
0	0	2:1	132	108
0	1	3:1	88	72
1	0	4:1	66	54
1	1	6:1	44	36

Table 4-6 Number of stored lines per field

4.6.2 Continuous Zoom

The continuous zoom feature changes the picture size rapidly in an animated manner. It is available in single-PIP mode for picture sizes smaller or equal 1/4 of the undecimated picture.

There are three possibilities of using the zoom feature:

- The PIP is zoomed via **HSHRINK** and **VSHRINK** manually. This requires an I²C protocol each time the picture size should change. **CZMEN** should be used to synchronize the update of **HSHRINK/VSHRINK** with **SIZEHOR/SIZEEVER**.
- A different way is to make usage of the *automatic* zooming. The zoom speed can be controlled by **CZMSPD**. When switching PIP on or off by using **PIPON**, the PIP zooms automatically to the selected picture size or disappears at size of 1/81.
- A zooming between two picture sizes can be performed by changing the **HSHRINK**, **VSHRINK**, **SIZEHOR**, **SIZEEVER** values when **CZMEN** is enabled. Then the new picture size is obtained by zooming and not taken immediately.

Automatic zooming is only possible in *frame mode*. Being in *field mode*, the picture size remains stable until frame mode occurs or until the internal counter reaches the desired

System Description

picture size. Then the size changes immediately. Equal to the wipe process, the zooming direction depends on the coarse position (CPOS).

VSHRNK	SIZEVER	625 lines		525 lines	
		Decimation Factor	Lines	Decimation Factor	Lines
0	0	2	132	2	108
1	0	2,03	130	2,03	106
2	0	2,06	128	2,08	104
3	0	2,09	126	2,13	102
4	0	2,13	124	2,16	100
5	0	2,16	122	2,2	98
6	0	2,2	120	2,25	96
7	0	2,23	118	2,3	94
8	0	2,28	116	2,34	92
9	0	2,31	114	2,41	90
10	0	2,36	112	2,45	88
11	0	2,41	110	2,52	86
12	0	2,44	108	2,58	84
13	0	2,48	106	2,64	82
14	0	2,53	104	2,7	80
15	0	2,59	102	2,77	78
16	0	2,64	100	2,84	76
17	0	2,69	98	2,92	74
18	0	2,75	96		
19	0	2,81	94		
20	0	2,88	92		
21	0	2,94	90		
0	1	3	88	3	72
1	1	3,07	86	3,09	70
2	1	3,14	84	3,19	68
3	1	3,21	82	3,28	66
4	1	3,3	80	3,38	64
5	1	3,38	78	3,49	62
6	1	3,47	76	3,61	60
7	1	3,56	74	3,73	58
8	1	3,66	72	3,87	56
9	1	3,77	70		
10	1	3,89	68		

VSHRNK	SIZEVER	625 lines		525 lines	
		Decimation Factor	Lines	Decimation Factor	Lines
0	2	4	66	4,01	54
1	2	4,13	64	4,15	52
2	2	4,25	62	4,31	50
3	2	4,41	60	4,5	48
4	2	4,56	58	4,69	46
5	2	4,72	56	4,9	44
6	2	4,88	54	5,13	42
7	2	5,06	52	5,39	40
8	2	5,28	50	5,7	38
9	2	5,5	48		
10	2	5,75	46		
0	3	6	44	6	36
1	3	6,28	42	6,38	34
2	3	6,61	40	6,75	32
3	3	6,94	38	7,22	30
4	3	7,31	36	7,73	28
5	3	7,78	34	8,3	26
6	3	8,25	32	9	24
7	3	8,81	30	9,8	22
8	3	9,42	28	10,78	20
9	3	10,17	26		
10	3	11,02	24		

Table 4-7 Number of stored lines per field dependent on VSHRNK

System Description

HSRKNK	SIZEHOR	Decimation Factor	stored Pixel	HSRKNK	SIZEHOR	Decimation factor	stored Pixel	HSRKNK	SIZEHOR	Decimation factor	stored Pixel
0	0	2,00	324	0	1	3,00	216	0	3	6,00	108
1	0	2,02	320	1	1	3,04	212	1	3	6,23	104
2	0	2,05	316	2	1	3,11	208	2	3	6,48	100
3	0	2,08	312	3	1	3,17	204	3	3	6,75	96
4	0	2,10	308	4	1	3,23	200	4	3	7,04	92
5	0	2,13	304	5	1	3,29	196	5	3	7,35	88
6	0	2,16	300	6	1	3,37	192	6	3	7,70	84
7	0	2,19	296	7	1	3,44	188	7	3	8,10	80
8	0	2,22	292	8	1	3,51	184	8	3	8,52	76
9	0	2,25	288	9	1	3,60	180	9	3	8,99	72
10	0	2,28	284	10	1	3,67	176	10	3	9,51	68
11	0	2,31	280	11	1	3,76	172	11	3	10,12	64
12	0	2,35	276	12	1	3,84	168	12	3	10,64	60
13	0	2,38	272	13	1	3,94	164				
14	0	2,41	268	0	2	4,05	160				
15	0	2,45	264	1	2	4,16	156				
16	0	2,49	260	2	2	4,27	152				
17	0	2,53	256	3	2	4,38	148				
18	0	2,57	252	4	2	4,50	144				
19	0	2,61	248	5	2	4,63	140				
20	0	2,66	244	6	2	4,77	136				
21	0	2,70	240	7	2	4,91	132				
22	0	2,74	236	8	2	5,06	128				
23	0	2,80	232	9	2	5,22	124				
24	0	2,84	228	10	2	5,41	120				
25	0	2,89	224	11	2	5,59	116				
26	0	2,95	220	12	2	5,78	112				

Table 4-8 Number of stored pixel per line dependent on HSHRKNK

4.6.3 Horizontal And Vertical Fine Positioning

All picture sizes are pre-centered inside the frame. In addition, if necessary the vertical and horizontal acquisition area can be shifted by **VFP** for vertical and **HFP** for horizontal direction.

System Description

4.6.4 Multi Display Mode

SDA 9589X and SDA 9489X offer the feature to display a sub-picture more than once. The picture size and arrangement depends on the display mode (**DISPMOD**) and not on **SIZEHOR** or **SIZEVER**. Hence variable scaling is not possible in these modes.

Display Mode	DISPMOD		Size	Picture configuration	Pixel	Lines	
	D1	D0				625	525
1	0	0	SIZEHOR/ SIZEVER HSRHNK/ VSHRNK	single PIP mode	324 - 60	132 - 24	108 - 20
2	0	1	3 X1/9	one upon another (same content)	216	264	216
3	1	0	4 X 1/16	one upon another (same content)	156	264	216

Table 4-9 Multi-display modes

The display modes are shown in the appendix. The sizes of the partial pictures are listed in table 4-11 .

4.6.5 Split Screen

For split screen applications two selectable 'double window' modes in which one half of the picture is generated by the 'Sophisticus'/'PIP IV Advanced' can be used. The split screen mode can be selected by two possible combinations of **DISPMOD**.

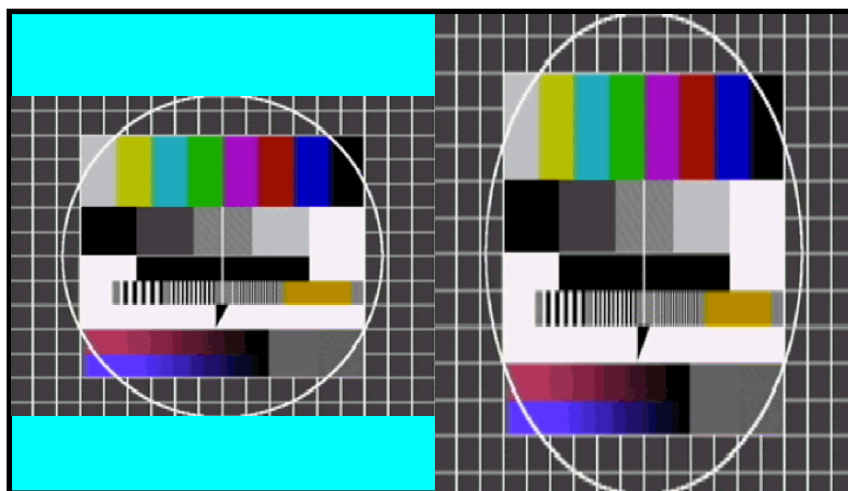


Figure 4-7 Double window mode 1.5 (left picture) and mode 1 (right picture)

System Description

The D1.5 mode is suited for displaying split screen on 16:9 tubes keeping the aspect ratio. The DW1 format covers the full height of the screen.

4.6.6 Multi-PiP Mode

There is a great variety of multi-pip modes available. Up to 11 different still pictures and one moving picture can be shown. This is useful to give an overview over broadcasted programmes (e.g. tuner-scan) or for supervising purposes. For multi-PiP modes only three fixed picture sizes are available (1/9, 1/16 or 1/36). The picture size and arrangement depends on the display mode (**DISPMOD**) and not on **SIZEHOR** or **SIZEVER**. Variable scaling is thus not possible in these modes. Because of limited memory capacity, the number of frozen multi-pictures is limited dependent on picture size to the number shown in the table below:

picture sizes	maximum number of pictures (including one live picture)
1/9	3
1/16	6
1/36	12

Table 4-10 Maximum number of pictures in multi-PIP mode

The partial picture that is written is addressed via **WRPOS**. With **INFRM**, a frame for separation of every PiP can be selected. This is adjustable to single or dual PIP mode (**INFRMOD**). The current updated picture can be highlighted with **PIPHLT**. To avoid garbage pictures after switching from one mode to another the selected picture can be blanked with **PIPBLK**. **MPIPBG** defines whether the picture will be blanked with black or with the adjusted background color.

For compatibility reasons to other devices, the **DISPMOD** register is split into two segments. If a display mode is chosen that is not implemented, the PIP insertion is switched off automatically (**PIPON** = '0'). The sizes of the partial pictures correspond to the sizes of the inset pictures of the single PIP modes.

System Description

Display Mode	DISPMOD					Size	Picture configuration	Pixel	Lines	
	D6	D5	D4	D3	D2				625	525
4	0	0	0	0	1	2 X 1/9,	one upon another	216	176	144
5	0	0	0	1	0	2 X 1/9,	side by side	432	88	72
6	0	0	0	1	1	3 X 1/9,	side by side	648	88	72
7	0	0	1	0	0	3 X 1/9	one upon another	216	264	216
8	0	0	1	0	1	4 X 1/16	side by side	624	66	54
9	0	0	1	1	0	6 X 1/16	inverted U shaped	624	132	108
10	0	0	1	1	1	6 X 1/16	U shaped	624	132	108
11	0	1	0	0	0	4 X 1/16	2 rows of 2 pictures	312	132	108
12	0	1	0	0	1	4 X 1/16	one upon another	156	264	216
13	0	1	0	1	0	12 X 1/36	6 rows of 2 pictures	216	264	216
14	0	1	0	1	1	12 X 1/36	2 rows of 6 pictures	648	88	72
15	0	1	1	0	0	9 X 1/36	3 rows of 3 pictures	324	132	108
16	0	1	1	0	1	12 X 1/36	3 rows of 4 pictures	432	132	108
17	0	1	1	1	0	11 X 1/36	angular of 11 pictures	648	264	216
18	0	1	1	1	1	9 X 1/36	angular of 9 pictures	540	220	180
19	1	0	0	0	0	1X1/3	Double Window (V=1.5)	324	176	144
20	1	0	0	0	1	1X1/2	Double Window (V=1)	324	264	216
21	1	0	0	1	0		OSD only			
	all other						PIP off (PIPON=0)			

Table 4-11 Display Modes

4.7 Display Control

The on-chip memory capacity is 768 kbits. Provided that the same standard (50 or 60 Hz) video sources are applied to inset and parent channel, joint-line free frame mode display is possible. This means that every incoming field is processed and displayed by the SDA 9589X/SDA 9489X processors. The result is a high vertical and time resolution. For this purpose the standard is analyzed internally and frame mode display is blocked

System Description

automatically, if the described restrictions are not fulfilled. Then only every second incoming field is shown (field mode). Field mode normally shows joint-lines. This is caused by an update of the memory during read out. The result is that one part of the picture contains new picture information and the other part contains one earlier written field. The switching from or to frame mode is free of artifacts.

Activation of frame-mode display is blocked automatically if at least one of the following conditions is not fulfilled:

- Inset and parent channel have the same field repetition frequency. This means that frame mode is possible only for 50Hz inset and parent sources or 60Hz inset and parent sources.
- Interlace signal is detected for inset and parent channel. For progressive scan or (S)VGA display therefore only field mode is possible. For some VCRs in trick mode, often no interlace is detected also.
- The number of lines is within a predefined range for inset (**FMACTI**) or parent (**FMACTP**) channel (assuming standard signals according to ITU)

FMACTP	parent standard	number of lines per field	FMACTI	inset standard	number of lines per field
0	50 Hz	310...315	0	50 Hz	310...315
1	50 Hz	290...325	1	50 Hz	290...325
0	60 Hz	260...265	0	60 Hz	260...265
1	60 Hz	250...275	1	60 Hz	250...275

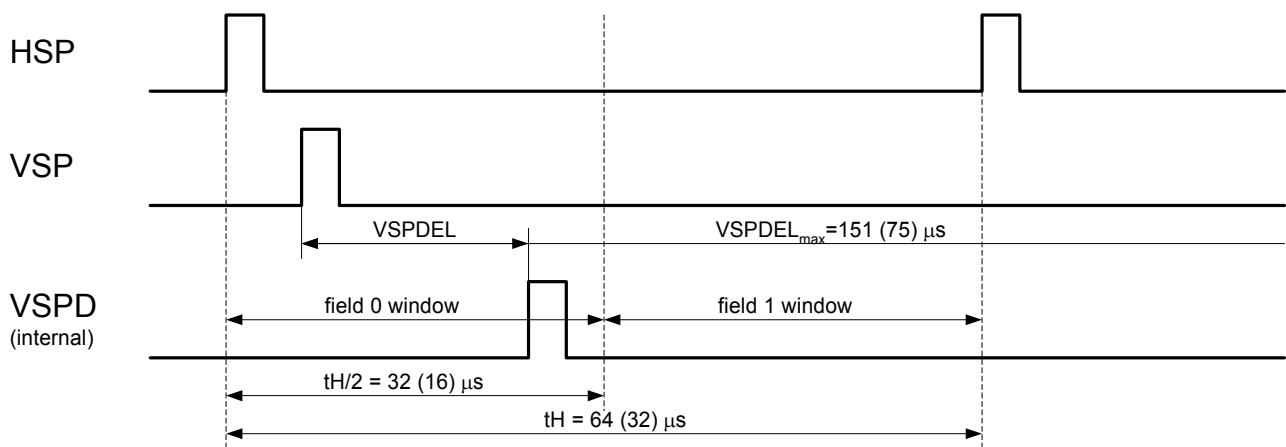
Table 4-12 Required number of lines for frame mode display

The system may be forced to field mode by means of **FIESEL**. Either first or second field is selectable. 'One of both' takes every second field independent of the field number. This is meant for sources generating only one field (e.g. video-games).

For progressive scan conversion systems and HDTV / (S)VGA displays a line doubling mode is available (**PROGEN**). Every line of the inset picture is read twice.

Memory writing is stopped by **FREEZE** bit. The field stored in the memory is then continuously read. As the picture decimation takes place before storing, the picture size of a frozen picture can not be changed.

Synchronization of memory reading with the parent channel is achieved by processing the parent horizontal and vertical synchronization signals connected to the pin HSP for horizontal synchronization and pin VSP for vertical synchronization. **HSPINV** or **VSPINV** respectively allow an inversion of the expected signal polarity.



values in brackets () apply for 100Hz systems

Figure 4-8 Field detection and phase adjustment of vertical pulse (VSP)

Depending on the phase between inset and parent signals a correction of the display raster for the read out data is performed. As the external VSP and HSP signals may come from different devices with different delay paths, the phase between V-sync and H-sync is adjustable (**VSPDEL**). An incorrect setting of **VSPDEL** may result in wrong or unreliable field detection of parent channel.

Normally a noise reduction of the incoming parent vertical pulse is performed. With this function missing vertical pulses are compensated. The circuit works for 50/60 Hz applications as well as progressive and 100/120Hz application. (S)VGA signals are supposed to be very stable and therefore not supported by the noise suppression. By means of **VSPNSRQ**, vertical noise suppression is switched off.

A great variety of combinations of inset and parent frequencies are possible. The following table shows some constellations.

System Description

Inset Frequency ¹⁾	Parent Frequency ¹⁾ (HSP/VSP)	frame mode	correct aspect ratio (single pip)	correct aspect ratio (multi display)	vertical noise suppression selectable
50	50i				
50	60i				
60	50i				
60	60i				
50	50p				
50	60p				
60	50p				
60	60p				
50	100i	2)			
50	120i				
60	100i				
60	120i	2)			
50	(S)VGA			3)	
60	(S)VGA			3)	

1) standard signals supposed

2) AABB only and picture size smaller than 1/9

3) valid for some parent frequencies. Please refer to **Chapter 4.7.2**

Table 4-13 Available Features with varying inset and parent standards

4.7.1 100 Hz Frame Mode

If the picture size is smaller or equal than 1/9 PIP a true frame mode display for 100Hz parent standard with a double field repetition rate is possible (display raster $\alpha\alpha\beta\beta$ only). The picture size is indicated by the horizontal and vertical decimation factors that must be equal or below 1/3 of undecimated picture size in both directions. This guarantees enough memory for a joint-line free picture with full vertical resolution. For bigger pictures only field mode is supported. The 100 Hz frame mode is activated if **READD='1'** for the above mentioned picture sizes. For an acceptable quality without line flicker or motion artifacts only the mode $\alpha\alpha\beta\beta$ is supported for HSP and VSP. If the sequence $\alpha\beta\alpha\beta$ is detected, the field mode will be activated again. Continuous switching between these modes is possible, resulting in continuous switching between field- and frame mode.

System Description

4.7.2 Mixed Standard Applications And (S)VGA Support

remark ($N_{\text{apel}} \times N_{\text{aline}} @ f_v$)	f_H (kHz)	T_H (μs)	T_{Hact} (μs)	lines/ active	f_{dot} (MHz)	scan	correct aspect ratio
720X576@50Hz (TV)	15.6	64.0	52.0	625/ 576	13.5	interlace	
702X488@60Hz (TV)	15.7	63.6	52.7	525/ 488	13.5	interlace	
720X576@100Hz (TV 100 Hz)	31.2	32.0	26.0	625/ 576	27	interlace	
702X488@120Hz (TV 120 Hz)	31.2	31.8	26.4	525/ 488	27	interlace	
720X576@50Hz (TV progressive)	31.2	32.0	26.0	625/ 576	27	prog- ressive	
702X488@60Hz (TV progressive)	31.2	31.8	26.4	525/ 488	27	prog- ressive	
640X480@60Hz (VGA)	31.5	31.8	25.4	525/ 480	25.2	prog- ressive	
640X480@72Hz (VGA)	37.9	26.4	20.3	520/ 480	31.5	prog- ressive	
640X480@75Hz (VGA)	37.5	26.7	20.3	500/ 480	31.5	prog- ressive	
800X600@56Hz (SVGA)	35.2	28.4	22.2	625/ 600	36.0	prog- ressive	
800X600@60Hz (SVGA)	37.9	26.4	20.0	625/ 600	40.0	prog- ressive	
800X600@72Hz (SVGA)	48.1	20.8	16.0	666/ 600	50.0	prog- ressive	
800X600@75Hz (SVGA)	46.9	21.3	16.2	625/ 600	49.5	prog- ressive	
800X600@85Hz (SVGA)	53.7	18.6	14.2	631/ 600	56.3	prog- ressive	
1024X768@43Hz (SVGA)	35.5	28.2	22.8	817/ 768	44.9	interlace	

Table 4-14 Examples of supported parent signals

System Description

SDA 9589X and SDA 9489X allow multiple scan rates for the use in desktop video applications, VGA compatible or 100Hz TV sets. All features are provided in 'normal' operating modes at auto detected 50Hz and 60 Hz parent and inset standards. $2f_H$ modes (100/120Hz and progressive) are supported by line frequency- and pixel clock doubling and are not detected automatically. Even on a 16:9 picture tube correct aspect ratio can be displayed by selecting the suitable parent clock. The video synthesizer generates also a special pixel clock for VGA display (see chapter 5.5.9 for details). As (S)VGA consists of a variety of scan rates the correct aspect ratio is not adjustable for all modes with the parent clock (**HZOOM**) because of the limited count of frequencies. For single PIP only, correct aspect ratio is maintained by the vertical and horizontal scaler (**HSHRINK** and **VSHRINK**).

It is possible to display (S)VGA sources for parent display, as long as the horizontal frequency is lower than 40 kHz and the signal does not contain more than 1023 lines. For progressive scan mode, **PROGEN** must be set. Additionally *field-mode* should be forced to prevent unallowed *frame-mode* displaying (**FIesel**). As the (S)VGA normally does not fit to the display raster generated in the vertical noise suppression, **VSPNSRQ** should be disabled. (S)VGA signals for inset channel are not supported.

PROGEN	READD	Expected input signal
0	0	50 or 60 Hz signal interlace
0	1	100 or 120 Hz signals interlace
1	0	(reserved)
1	1	50 or 60 Hz or (S)VGA signal progressive

Table 4-15 Selection of display field repetition

4.7.3 Display standard

For a single-PiP, the number of displayed lines depends on the selected picture size and on the signal standard. For multi picture display, the number of displayed lines depends on the selected picture size and on the signal standard of the parent signal. Additionally, a standard can be forced by **DISPSTD**.

System Description

DISPSTD		DISPMOD	Display Standard
D1	D0		
0	0	0	PIP depends on detected inset standard (single pip)
0	0	>0	PIP depends on detected parent standard (multi display)
0	1	x	PIP display is always in 625 lines mode
1	0	x	PIP display is always in 525 lines mode
1	1	x	freeze last detected display standard and size

Table 4-16 Display standard selection

If a 625 lines picture is shown with a 525 lines parent signal, some lines are missing on top and bottom of picture. If a 525 lines picture is shown with a 625 lines display standard, missing lines at top and bottom are filled with background color or black depending on **MPIPBG**.

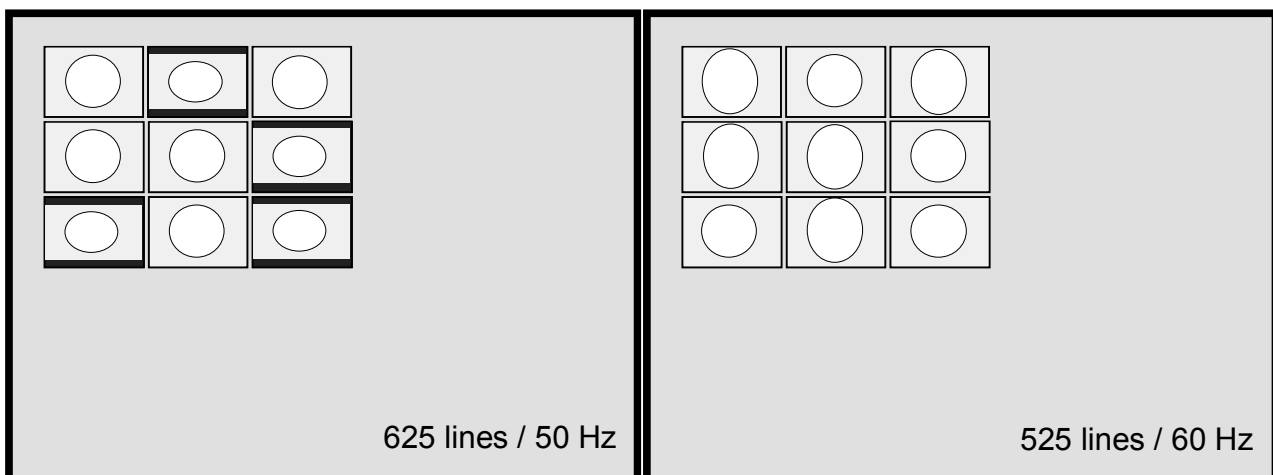


Figure 4-9 50 and 60 Hz Multi PiP display on 50 Hz and 60 Hz display

4.7.4 Picture Positioning

The display position of the inset picture is programmable to the 4 corners of the parent picture (**CPOS**). From there PIP can be moved to the middle of the TV Picture with **POSHOR** and **POSVER**. The corner positions can be centered coarsely on the screen with **POSOFH** and **POSOFV**. Depending on coarse position, one PIP corner remains stable when changing the picture size.

System Description

CPOS		Coarse Position	Reference corner of PiP	increasing POSVER	increasing POSHOR
D1	D0				
0	0	upper left	upper left	down	right
0	1	upper right	upper right	down	left
1	0	lower left	lower left	up	right
1	1	lower right	lower right	up	left

Table 4-17 Coarse Positioning

There are 256 horizontal locations (4 pixel increments) and 256 vertical locations (2 line increments). The pixel width on the screen depends on the selected **HZOOM** factor. Even POP-positions (Picture Outside Picture) in 16:9 applications are possible.

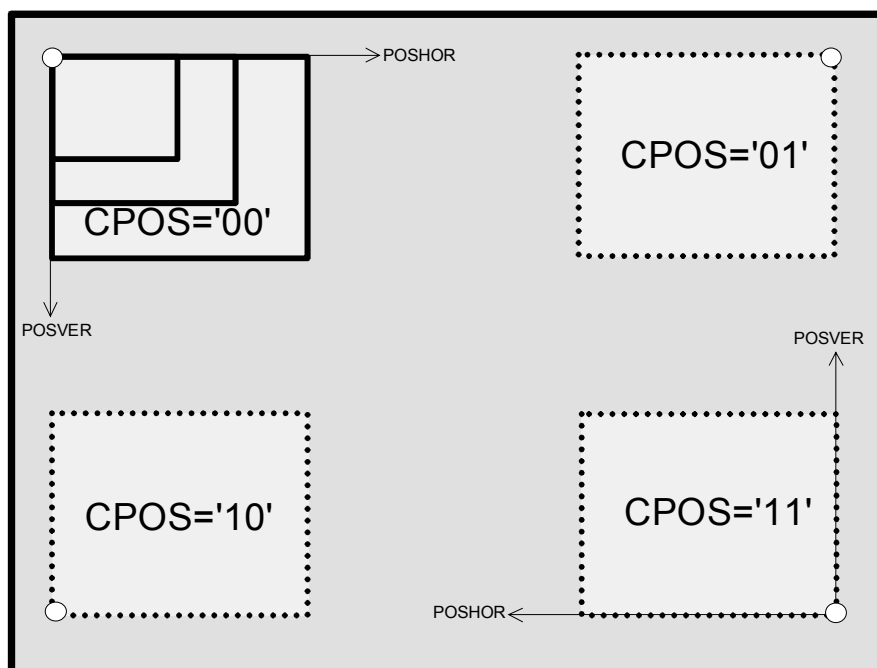


Figure 4-10 Coarse Positioning

4.7.5 Wipe In / Wipe Out

With the wipe in / wipe out function it is possible to let appear or disappear the complete inset picture starting or ending at the corner of the inset picture position defined by **CPOS**. Thereby the size of the visible picture-part is continuously increased and decreased respectively. During this procedure the frame is shown with its chosen widths. 3 different wipe in / out time periods or 'no wipe' are programmable via **WIPESPD**. The wipe algorithm always works in horizontal and vertical direction.

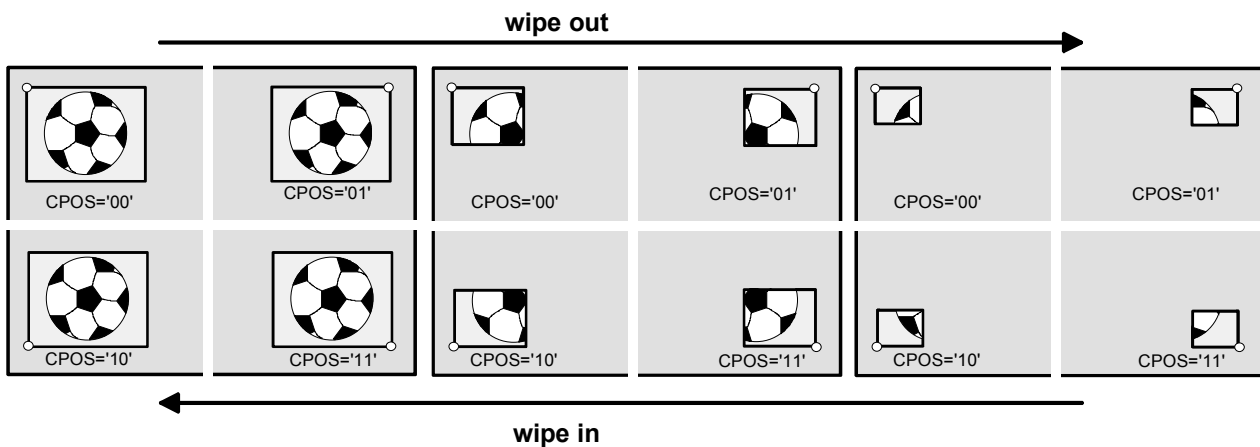


Figure 4-11 Wipe display

If **WIPESPD** is set accordingly, **PIPON** controls the wipe operation. When **PIPON** changes the wipe operation starts. During this period, the readable **PIPSTAT** indicates the ongoing wipe-process. A transition of **PIPON** from '0' to '1' triggers the wipe-in. The wipe-in process stops when the picture reaches its programmed size. When **PIPON** changes from '1' to '0' the wipe-out starts. The wipe-out is finished when the PiP picture vanishes. Even for multi-picture display wipe operation is possible. A change of **PIPON** or **WIPESPD** during wipe operation has only an effect after the wipe operation has been finished.

4.8 Output Signal Processing

4.8.1 Luminance Peaking

To improve picture sharpness, a peaking filter which amplifies higher frequencies of the input signal is implemented. The amount of peaking can be varied in seven steps by **YPEAK**. The setting '000' switches off the peaking. The value '001' is recommended as This value provides a good compromise between sharpness impression and annoying aliasing. The characteristic for all possible settings is shown in fig. (4-12). The emphasized frequency depends on the adjusted decimation. The gain maximum is always located before the band-limit ensuring optimal picture impression.

System Description

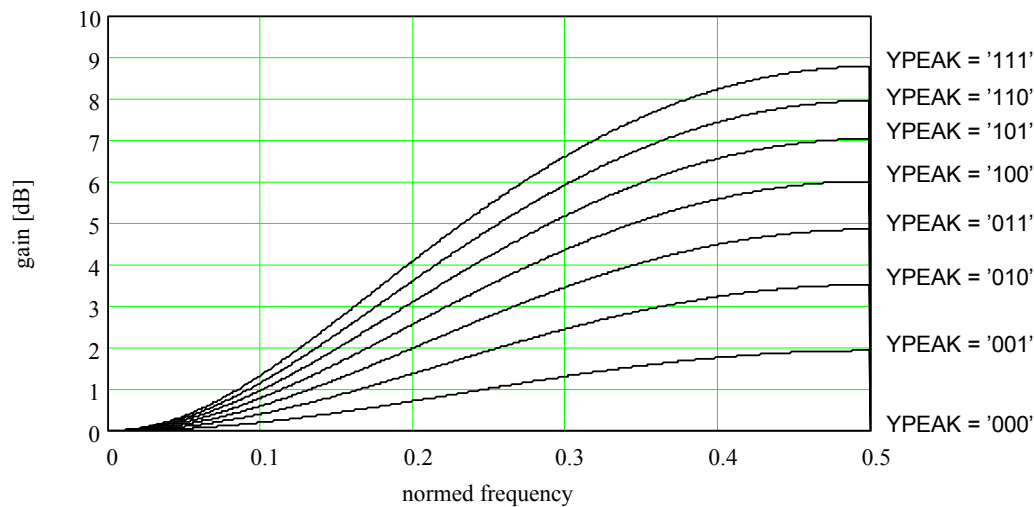


Figure 4-12 Characteristics of selectable peaking factors (0.5 = band limit)

Coring should be switched on by **YCOR** to reduce noise, which is also amplified when peaking is enabled. As the coring stage is in front of the peaking filter, 1 LSB noise will not be peaked.

4.8.2 RGB Matrix

The chip contains three different matrices, one suited for EBU standards, one suited for NTSC-Japan and one suited for NTSC-USA, which are selected via **MAT**. The signal **OUTFOR** switches between YUV output or RGB output. The signal **UVPOLAR** inverts the U and V channels and results in Y-U-V output. The standard magnitudes and angles of the color-difference signals in the UV-plane are defined as follows:

MAT		Magnitudes			Angles			Standard
D1	D0	(B-Y)	(R-Y)	(G-Y)	(B-Y)	(R-Y)	(G-Y)	
0	0	2.028	1.14	0.7	0	90	236	EBU
0	1	2.028	1.582	0.608	0	95	240	NTSC (Japan)
1	0	2.028	2.028	0.608	0	105	250	NTSC (USA)
1	1							(reserved)

Table 4-18 RGB matrices characteristics

The color saturation can be adjusted with **SATADJ** register in 16 steps between 0 and 1.875. Values above 1.0 may clip the chrominance signals.

System Description

4.8.3 Frame Generation And Colored Background

With **FRSEL** a colored frame is added to the inset picture. The chip can display two different types of frames, one simple monochrome frame and a more sophisticated frame giving a three dimensional impression.

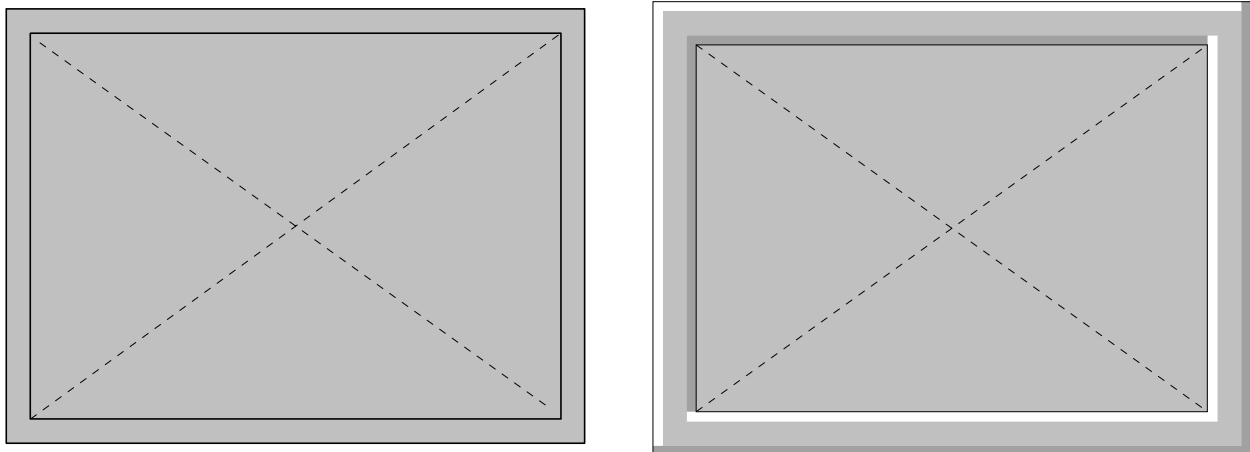


Figure 4-13 Normal frame and 3D frame

The frame elements are always placed outside the inset picture, except for the inner shade of three dimensional frame or inner frame in multi-pip mode. There is no shift of the inset picture position if the inset frame width is modified.

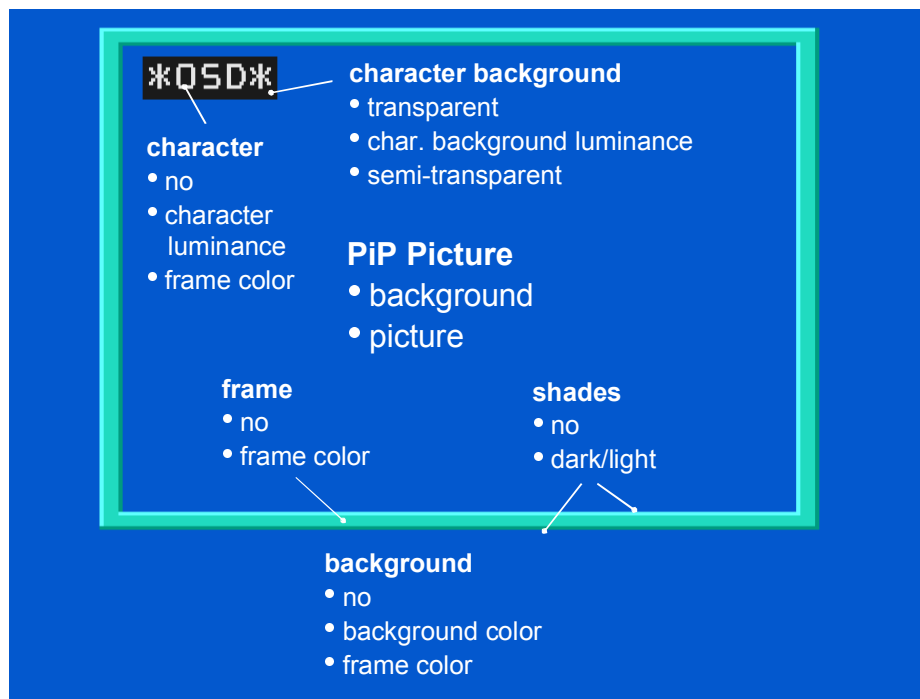


Figure 4-14 Selectable picture configurations

System Description

4096 frame colors are programmable by **FRY**, **FRU**, and **FRV**, 4 bits for each component. Horizontal and vertical width of the frame are programmable independently by **FRWIDH** and **FRWIDV**. If desired, frame color is displayed over the whole PIP size or whole picture size of the main channel when **PIPBG** is set accordingly. 64 background colors are programmable by **BGY**, **BGU**, **BGV**, 2 bits for each component. Alternatively **BGFRC** sets the background to frame color.

4.8.4 16:9 Inset Picture Support

To remove dark stripes at 16:9 inset pictures the vertical display area is shrinkable with **VPSRED**. The number of omitted lines depends on the vertical decimation factor.

vertical decimation factor	displayed lines (50Hz)	displayed lines (50Hz) with reduction	displayed lines (60Hz)	displayed lines (60Hz) with reduction
1	264	214	216	175
...				
6	44	35	36	29

Table 4-19 Number of lines without and with reduction of vertical picture size



Figure 4-15 16:9 inset picture without and with reduction of vertical picture size

4.8.5 Parent Clock Generation

The phase of the output signals is locked to the rising edge of the horizontal sync pulse. The frequency varies in a certain range to ensure correct aspect ratio for 16:9 applications depending on **HZOOM**. The horizontal and vertical scaling can be used for all display frequencies.

System Description

display format	inset picture format	desired PiP format	required parent frequency	value of HZOOM		
				D2	D1	D0
4:3	4:3	4:3	27	0	0	0
4:3	4:3	16:9	20.25	0	0	1
16:9	4:3	4:3	36	0	1	0
16:9	16:9	16:9	36	0	1	0

Table 4-20 Format conversion using HZOOM

For variations of parental horizontal frequency (e.g. VCR), a digital correction of the position is useful to stabilize the picture (**POSCOR**). This circuit detects a varying parental line frequency and moves the picture to the place, where it would have been without this frequency deviation. The deviation is calculated once a field.

4.8.6 Select Signal

For controlling an external RGB or YUV switch a select signal is supplied. The delay of this signal is programmable for adaptation to different external output signal processing devices (**SELDEL**).

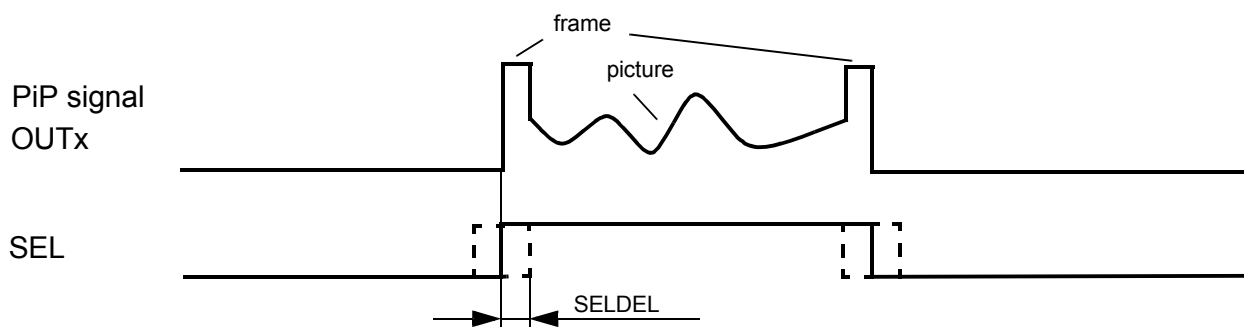


Figure 4-16 Select timing

4.8.7 Automatic Brightness Reduction

Displaying a bright PiP picture, the beamcurrent-limitation of the parent system may become active. This may cause the parent picture to be influenced by the inset picture. Therefore a detection circuit reduces the brightness of the inset picture when the average brightness is above a selectable threshold. After bright picture content has disappeared, the initial brightness reappears. The threshold is adjustable via **ABRTHD** and the speed via **ABRSPD**. Both settings have to be selected for parent system accordingly.

4.9 On Screen Display (OSD)

4.9.1 Display Format

The on screen display allows to insert a block of 5 characters into each of the PiP pictures. The characters are placed in a box (background) whose width is 64 pixels and height is 12 lines. This box is placed in the upper left corner of the PiP picture. 64 different characters are stored in a character ROM. Each character is defined by a pixel matrix consisting of 10 lines and 12 pixels per line. A doubling of the character's height and width is achieved by **CHRDHW**. The OSD starting position is not influenced.

OSD display is also possible if PiP is switched off (**DISPMOD** = '100011'). Now 3 lines of 20 characters each are displayed at the PiP position.



Figure 4-17 Example of OSD-only mode

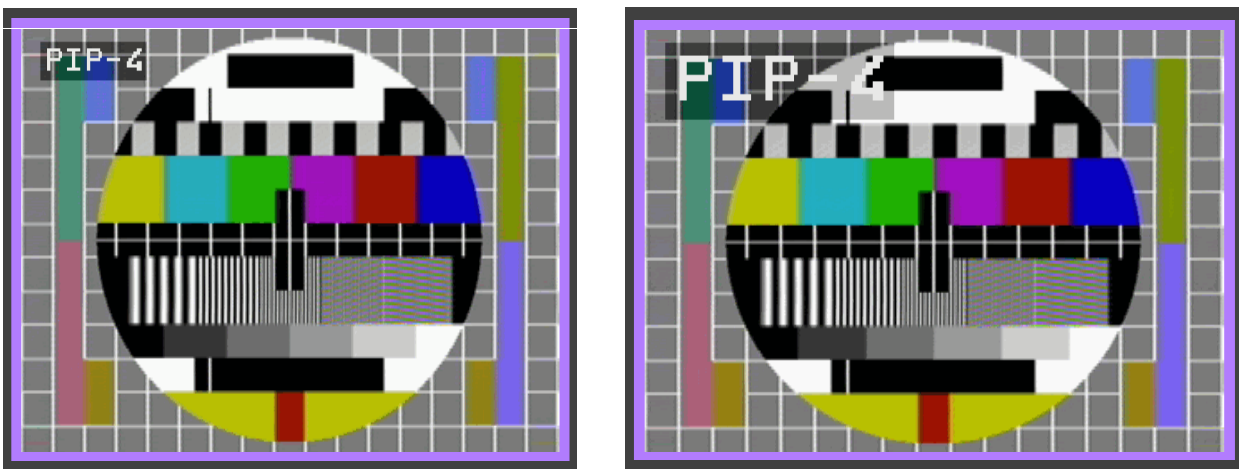


Figure 4-18 Example of transparent mode (normal and double size OSD)

4.9.2 Character Programming

The characters are programmed via I²C bus using a 7 bit code which is identical with the ASCII code except for some of the special characters. The codes are stored in a character RAM consisting of 60 cells. The character codes can be transmitted in two ways: each character position can be addressed separately by its 7 bit address or the characters can be written consecutively starting at an arbitrarily chosen position. In this case the address is increased automatically. The 7 bit address consists of two parts: the 4 MSBs are used to choose one of the partial pictures and the 3 LSBs to select one of the 5 characters per block.

4.9.3 Character and Character Background Color

The character's color is either same as frame color (**CHRFRC**) or the character appears with a grey value programmable with **CHRY**.

The character's background box is influenced by **CHRBGON** and **CHRBGY**. It can be made transparent so that behind the characters the inset picture becomes visible. Alternatively the semi-transparent mode can be chosen. At this mode the background box contains the original picture content with reduced luminance value. This mode offers a good trade-off between reduction of visible display area and character readability.

4.10 DA-Conversion And RGB / YUV Switch

SDA 9589X and SDA 9489X include three 7bit DA-converters. Brightness **BRTADJ**, Contrast **CONADJ** and overall amplitude **PKLR**, **PKLG**, **PKLB** of the output signal are adjustable. External RGB or YUV signals can be connected to the inputs IN1...3. By forcing the FSW input to high-level these signals are switched to the outputs OUT1...3 while the internal signals are switched off. The FSW input signal is passed through to the SEL output. The setting of **RGBINS** determines whether an RGB insertion is possible and which source, the external picture or the PiP, gets priority.

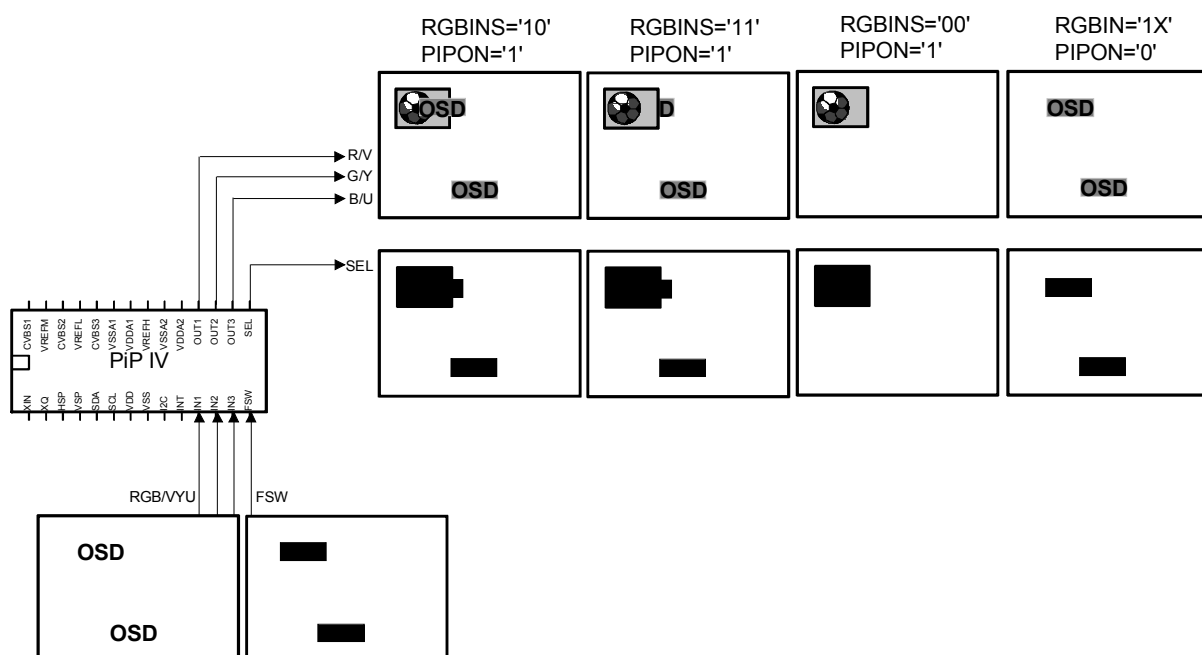


Figure 4-19 Visualization of RGB/YUV insertion

The external RGB or YUV signals are each clamped to the reference levels of the DACs to force uniform black levels in each channel. The clamping needs careful adjustment especially for VGA applications. The position and the length of the blanking pulse as well as the clamping pulse are adjustable (**CLPPOS**, **CLPLEN**). If **READD** is set to '1' (100Hz mode), all pulses are shortened by one half. **HZOOM** influences the adjustment range of

System Description

the clamping and blanking pulse because of the modified clock frequency, but the pulse length is kept nearly constant.

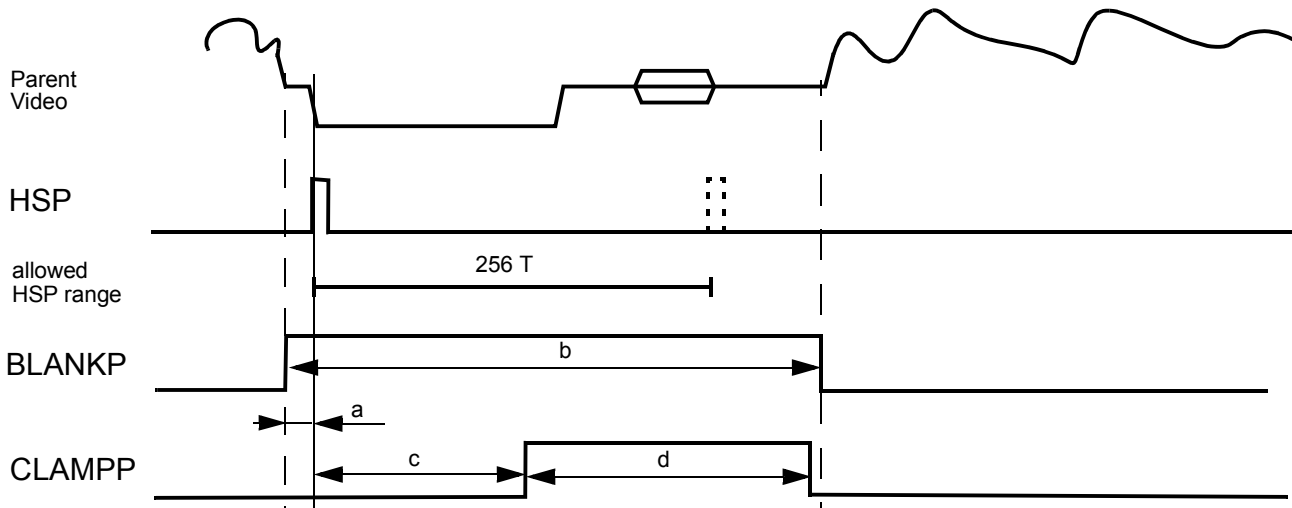


Figure 4-20 PIP horizontal blanking timing

READD	CLPDEL			CLPLEN		a (μs) Blanking Start	b (μs) Blanking Duration	c (μs) Clamping Start	d (μs) Clamping Duration
	D2	D1	D0	D1	D0				
0	0	0	0	0	0	-1.5	10.5	3	5
0	1	1	1	0	0	-11	10.5	-6.4	5
0	0	0	0	0	1	-1.5	7.9	2.2	3.8
0	1	1	1	0	1	-11.0	7.9	-7.3	3.8
1	0	0	0	0	0	-0.8	5.3	1.5	2.5
1	1	1	1	0	0	-5.5	5.3	-3.2	2.5
1	0	0	0	0	1	-0.8	4	1.1	1.9
1	1	1	1	0	1	-5.5	4	-3.6	1.9

Table 4-21 PIP horizontal blanking timing

4.10.1 Pedestal Level Adjustment

The pedestal level adjustment controlled by I²C signals **BLKLR**, **BLKLG**, **BLKLB** enables the correction of small offset errors, possibly appearing at the successive blanking stage of RGB processor. This adjustment has an effect on the setup level during the active line interval of each channel like the brightness adjustment but has an

System Description

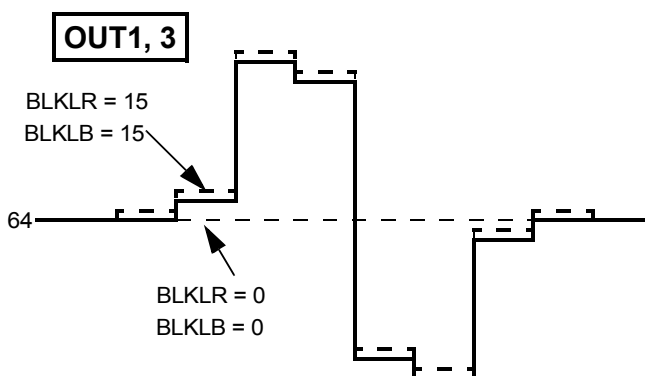
enhanced resolution of 0.5 LSB. The maximum possible offset amounts to 7.5 LSBs. In YUV mode (**OUTFOR** = '1') the action depends on the setting of **BLKINVR** and **BLKINVB**. If **BLKINVR** (**BLKINVB**) is active the offset applies to the blank level of the **RV** (**BU**) channel during the clamping interval for shifting the setup level to the negative direction. In RGB mode (**OUTFOR** = '0') **BLKINVR** and **BLKINVB** have no effect.

4.10.2 Contrast, Brightness and Peak Level Adjustment

The peak level adjustment modifies the magnitude of each channel separately. It should be used to adapt once the signal levels to the following stage. The contrast adjustment influences all three channels and allows a further increase of 30% of the peak level magnitude. The effect of the brightness adjustment depends on the selected output mode (RGB/YUV). In YUV mode it changes the offset of the OUT2 (Y) signal only while in RGB mode it changes the offset of all three channels at the same time. The brightness increase is up to 20%.

OUTFOR = '1' (YUV Mode)

BLKINVR = BLKINVB = '0'



BLKINVR = BLKINVB = '1'

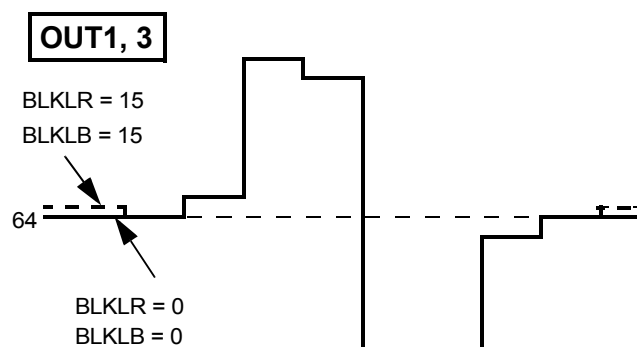
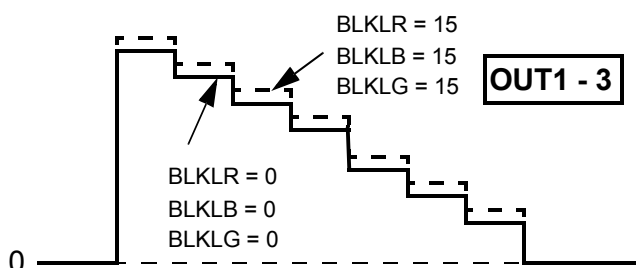
**OUTFOR = '0' (RGB Mode)**

Figure 4-21 Pedestal level adjustment

System Description**4.11 Data Slicer**

Depending on **SERVICE**, Closed Caption data ('Line 21') or WSS (Widescreen signalling) is sliced by the digital data slicer and can be read out from I²C interface. The line number of the sliced data is selectable with **SELLNR**. Therefore WSS and CC can be processed in different regions (e.g. CC with PAL M). The Closed Caption data is assumed to conform with the ITU standards EIA-608 and EIA-744-A. WSS data is assumed to conform with ETS 300 294 (2nd edition, May 1996).

4.11.1 Closed Caption

The closed caption data stream contains different data services. In field 1 (line 21) the captions CC1 and CC2 and the text pages T1 and T2 are transmitted whereas in field 2 (line 284) caption CC3, CC4, text T3, T4 and the XDS data are transmitted. For more information please refer to the above mentioned standards.

Raw CC as well as prefiltered data is provided alternatively. With the built-in programmable XDS-Filter (**XDSCLS**), the program-rating information ('V-chip') as well as others can be filtered out. The XDS filter reduce traffic on the I²C bus and save calculation power of the main controller. If no class filter is selected, all incoming data (both fields) is sliced and provided by the I²C interface. When one or more class filters are chosen, only data in field 2 is sliced. Any combination of class filters is allowed. Each 'CLASS' is divided into 'TYPES' which can be sorted out by the XDS-secondary filter (**XDSTPE**). Any combination of type filter is allowed. Some type filter require an appropriate class filter.

4.11.2 Widescreen Signalling (WSS)

In WSS mode (**SERVICE**='1') no filtering is possible. All sliced data is passed to the output registers. In this case **XDSTPE** selects the field number of the data to be sliced. In Europe WSS carries for instance information about aspect ratio and movie mode.

4.11.3 Indication Of New Data

The sliced and possibly filtered data is available in **DATAA** and **DATAB**. The corresponding status bits are **DATAV** and **SLFIELD**. When new data were received, **DATAV** becomes '1' and the controller must read **DATAA**, **DATAB** and the status information. After both data bytes were read **DATAV** becomes '0' until new data arrives. It must be ensured that the data polling is activated once per field (16.7 or 20 ms) or every second field (33.3 or 40 ms), depending on the slicer configuration and inset field frequency. The field number of the data in **DATAA** and **DATAB** can be found in **SLFIELD**. If one or more XDS-class filter are activated, **SLFIELD** contains always '1'.

Additionally pin 10 (INT) may flag that new data is received. Default this pin is in tri-state mode to be compatible with Micronas' SDA9388X/9389X PIP devices. It can also be configured by **IRQCON** to output a single short pulse when new data is available or behave equal to **DATAV**. In the last case the output remains active until the two data

System Description

registers **DATAA/DATAB** are read. Both modes are useful to avoid continuous polling of the I2C bus. The micro-controller initiates I2C transfers only when required.

```

while (1){
    i2c_read pip4_adr, status_reg_adr, status
    if (status & data_valid_mask) {
        i2c_read_inc pip4_adr, dataa_reg_adr, dataa, datab, status
        process_data dataa, datab, status
    }
}

```

Figure 4-22 Example in pseudo-code for reading the data

4.11.4 Violence Protection

The rating information is sent in the program rating packet of the current (sometimes future) class in the XDS data stream. If only this information is desired the corresponding XDS filter (class 01h, type 05h) should be used to suppress other data. The class/packet bytes (0105h) precede the 2 bytes rating information. Each sequence is closed by the end-of-packet byte (0fh) and a checksum. This checksum complements the byte truncated sum of all bytes to 00h. Except comparison of the received rating with the adjusted user rating threshold the micro-controller should check the parity of each byte and validate the checksum to avoid miss-interpretation of wrong received data.

The SDA 9589X/SDA 9489X offer some alternatives to blocking the PIP channel completely by switching it off (fig. (4-23)).

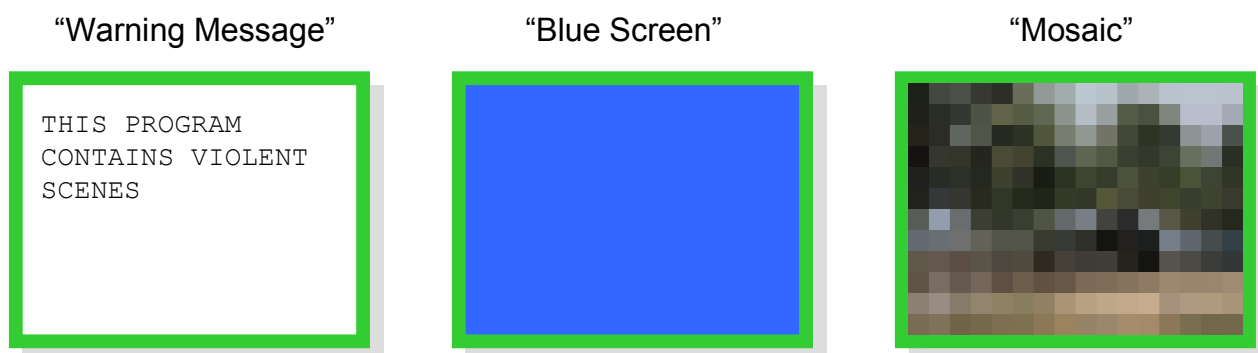


Figure 4-23 Possibilities of PiP blocking

The Mosaic mode (**MOSAIC**) hides details of the picture by reduced sharpness and increased aliasing. The picture looks scrambled and is less perceptible.

5 Application Examples

The following two figures show 100/120Hz applications with the Micronas Featurebox SDA 9400/01. As the chip supports two I2C addresses and owns a RGB switch dual-PIp applications are easy to implement. The arrangement for best possible performance is shown in the fig. (5-1).

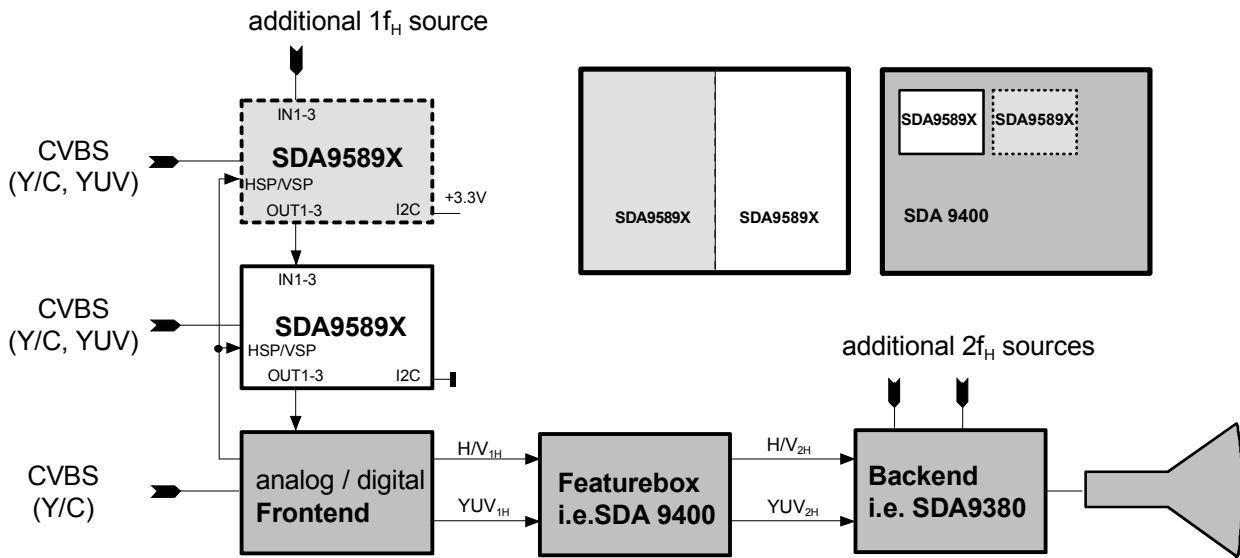


Figure 5-1 SDA 9589X application with insertion in front of the featurebox

The output of two 'SOPHISTICUS' are connected to the YUV (or RGB) input of the video processor of the main channel. Due to the 4:2:2 processing within the SDA 9400 the inset picture remains brilliant.

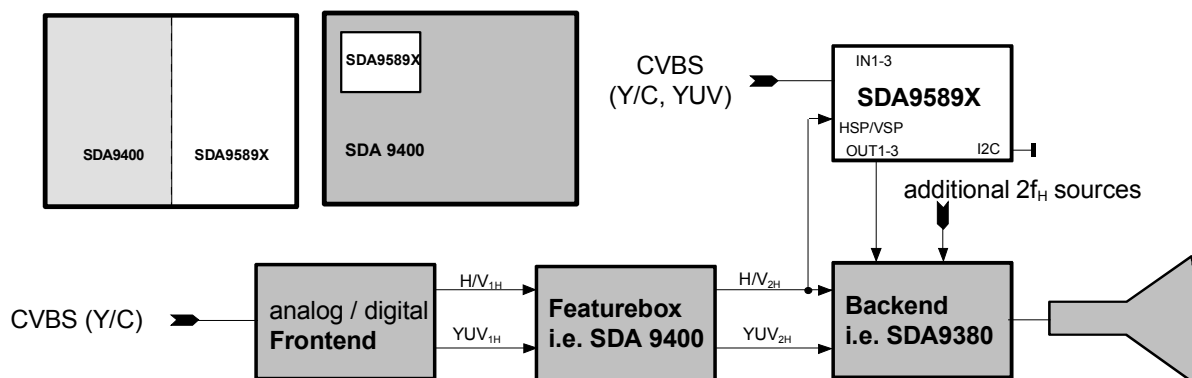


Figure 5-2 SDA 9589X application with insertion behind the featurebox

Connecting the SDA 9589X/SDA 9489X directly to the RGB input of the RGB processor is possible as well. One picture is generated from SDA 9589X/SDA 9489X device, the other one from the featurebox. This cheap implementation preserves the chroma of inset channel at its full bandwidth, although frame mode is only possible for PiP pictures

Application Examples

smaller than 1/9. The output of an OSD/Text processor may be fed to the RGB switch of the SDA 9589X/SDA 9489X.

6 I²C Bus**6.1 I²C Bus Address**

Write Address1	1	1	0	1	0	1	1	0	(D6h)
Read Address1	1	1	0	1	0	1	1	1	(D7h)

Table 6-1 Primary Address (pin 9='low-level')

Write Address2	1	1	0	1	1	1	1	0	(DEh)
Read Address2	1	1	0	1	1	1	1	1	(DFh)

Table 6-2 Secondary Address (pin 9 = 'high-level')**6.2 I²C-Bus Format**

WRITE	S	1101x110	A	Subaddress	A	Data Byte		A	****	A	P
READ	S	1101x110	A	Subaddress	A	Sr	1101x111	A	Data Byte n	NA	P
S: Start condition / Sr Repeated start condition / A: Acknowledge / P: Stop condition / NA: No Acknowledge											

Write operation is possible at registers 00h-21h only, read operation is possible at registers 28, 2Ah-2Ch only. An automatic address increment function is implemented.

6.3 I²C bus Command Table

Subadd (Hex)	Data Byte							
	D7	D6	D5	D4	D3	D2	D1	D0
00h	PIPON	CPOS1	CPOS0	YUVSEL	READD	PROGEN	FIESEL1	FIESEL0
01h	POSHOR7	POSHOR6	POSHOR5	POSHOR4	POSHOR3	POSHOR2	POSHOR1	POSHOR0
02h	POSVER7	POSVER6	POSVER5	POSVER4	POSVER3	POSVER2	POSVER1	POSVER0
03h	VFP3	VFP2	VFP1	VFP0	HFP3	HFP2	HFP1	HFP0
04h	DISPSTD1	DISPSTD0	FREEZE	MOSAIC	SIZEHOR1	SIZEHOR0	SIZEVER1	SIZEVER0
05h	FPSTD1	FPSTD0	PIPBG1	PIPBG0	FMACTP	HZOOM2	HZOOM1	HZOOM0
06h	HSPINV	VSPINV	VSPNSRQ	VSPDEL4	VSPDEL3	VSPDEL2	VSPDEL1	VSPDEL0
07h	FRSEL	INFRM	VPSRED	FRWIDTH2	FRWIDTH1	FRWIDTH0	FRWIDV1	FRWIDV0
08h	RGBINS1	RGBINS0	VERBLK	SELDOWN	SELDEL3	SELDEL2	SELDEL1	SELDEL0
09h	POSCOR	DISPMOD1	DISPMOD0	CLPDEL4	CLPDEL3	CLPDEL2	CLPDEL1	CLPDEL0
0Ah	AGCRES	AGCMD1	AGCMD0	AGCVAL3	AGCVAL2	AGCVAL1	AGCVAL0	NOSIGB
0Bh	CVBSEL1	CVBSEL0	CLMPID1	CLMPID0	CLMPIST1	CLMPIST0	LMOFST1	LMOFST0
0Ch	PLLITC1	PLLITC0	NSRED1	NSRED0	YCDEL3	YCDEL2	YCDEL1	YCDEL0
0Dh	CSTAND2	CSTAND1	CSTAND0	CSTDEX1	CSTDEX0	LOCKSP	CKILL1	CKILL0
0Eh	BGPOS	SCMIDL0	DEEMP1	DEEMP0	COLON	ACCFIX	CHRBW1	CHRBW0
0Fh	IFCOMP1	IFCOMP0	HUE5	HUE4	HUE3	HUE2	HUE1	HUE0
10h	SATNR	FMACTI	CPLLOF	SCADJ4	SCADJ3	SCADJ2	SCADJ1	SCADJ0
11h	CONADJ3	CONADJ2	CONADJ1	CONADJ0	BLKLR3	BLKLR2	BLKLR1	BLKLR0
12h	BRTADJ3	BRTADJ2	BRTADJ1	BRTADJ0	BLKLG3	BLKLG2	BLKLG1	BLKLG0
13h	TRIOUT	REFINT	BLKINVR	BLKINVB	BLKLB3	BLKLB2	BLKLB1	BLKLB0
14h	PKLR7	PKLR6	PKLR5	PKLR4	PKLR3	PKLR2	PKLR1	PKLR0
15h	PKLG7	PKLG6	PKLG5	PKLG4	PKLG3	PKLG2	PKLG1	PKLG0
16h	PKLB7	PKLB6	PKLB5	PKLB4	PKLB3	PKLB2	PKLB1	PKLB0

I2C Bus

Subadd (Hex)	Data Byte							
	D7	D6	D5	D4	D3	D2	D1	D0
17h	MAT1	MAT0	BGY1	BGY0	FRY3	FRY2	FRY1	FRY0
18h	OUTFOR	UVPOLAR	BGU1	BGU0	FRU3	FRU2	FRU1	FRU0
19h	(reserved)	BGFRC	BGV1	BGV0	FRV3	FRV2	FRV1	FRV0
1Ah	SATADJ3†	SATADJ2	SATADJ1	SATADJ0†	YPEAK2	YPEAK1	YPEAK0	YCOR
1Bh	XDSCLS4	XDSCLS3	XDSCLS2	XDSCLS1	XDSCLS0	XDSTPE2	XDSTPE1	XDSTPE0
1Ch	UVSEQ	MPIPBG	SERVICE	SELLNR1	SELLNR0	IRQCON2	IRQCON1	IRQCON0
1Dh	(reserved)	(reserved)	(reserved)	(reserved)	(reserved)	PIPLK	PALIDL1	PALIDL0
1Eh	POSOFV2	POSOFV1	POSOFV0	POSOFH4	POSOFH3	POSOFH2	POSOFH1	POSOFH0
1Fh	(reserved)	(reserved)	(reserved)	VSHRNK4	VSHRNK3	VSHRNK2	VSHRNK1	VSHRNK0
20h	(reserved)	(reserved)	(reserved)	HSHRNK4	HSHRNK3	HSHRNK2	HSHRNK1	HSHRNK0
21h	(reserved)	(reserved)	(reserved)	(reserved)	(reserved)	(reserved)	CLPLEN1	CLPLEN0
22h	PIPHLT	ABRTHD3	ABRTHD2	ABRTHD1	ABRTHD0	ABRSPD2	ABRSPD1	ABRSPD0
23h	INFRMOD	DISPMOD6	DISPMOD5	DISPMOD4	DISPMOD3	DISPMOD2	WIPESP1†	WIPESP0
24h	CZMEN	CZMSP1	CZMSP0	(reserved)	WRPOS3	WRPOS2	WRPOS1	WRPOS0
25h	CHRFRC	CHRDHW	CHRY1	CHRY0	CHRBGY1	CHRBGY0	CHRBGON 1	CHRBGON 0
26h	OSDON	CHRADR6	CHRADR5	CHRADR4	CHRADR3	CHRADR2	CHRADR1	CHRADR0
27h	CHRCLR	CHRCOD6	CHRCOD5	CHRCOD4	CHRCOD3	CHRCOD2	CHRCOD1	CHRCOD0
28h	FRMMD	PIPSTAT	SYNCST1	SYNCST0	CKSTAT	STDET2	STDET1	STDET0
29h	(reserved)	(reserved)	(reserved)	(reserved)	(reserved)	(reserved)	(reserved)	(reserved)
2Ah	DATAA7	DATAA6	DATAA5	DATAA4	DATAA3	DATAA2	DATAA1	DATAA0
2Bh	DATAB7	DATAB6	DATAB5	DATAB4	DATAB3	DATAB2	DATAB1	DATAB0
2Ch			DEVICE1	DEVICE0	PRNSTD	PALID	DATAV	SLFIELD

After power on the grey marked data bits are set to '1', all other to '0'.

6.4 I²C Bus Command Description

Subaddress 00h

PIPON	PIP on
D7	switches the PIP insertion on
0	PIP insertion off
1	PIP insertion on

CPOS		Coarse position
D6	D5	coarse positioning of the picture
0	0	upper left position
0	1	upper right position
1	0	lower left position
1	1	lower right position

YUVSEL	YUV Select
D4	select YUV mode
0	CVBS or Y/C source
1	YUV source

READD	Read Double Mode
D3	double read frequency for compatibility with systems that use 2fH (e.g. 100 Hz, progressive)
0	PIP display with single read frequency and 2x oversampling
1	PIP display with double read frequency

PROGEN	Progressive Scan Enable
D2	for compatibility with progressive scan systems
0	each line of PIP is read once (normal operation)
1	each line of PIP is read twice (line doubling operation)

FIESEL		Field Select
D1	D0	set field or frame display mode
0	0	frame mode (if possible)
0	1	field mode (first field only)
1	0	field mode (second field only)
1	1	field mode (one of both)

Subaddress 01h

POSHOR	Horizontal Picture Position
D7-D0	horizontal position adjustment of the PIP in steps of 4 pixel shift direction depends on the coarse positioning of the picture

Subaddress 02h

POSVER	Vertical Picture Position
D7-D0	vertical position adjustment of the PIP in steps of 1 lines shift direction depends on the coarse positioning of the picture

Subaddress 03h

HFP				Horizontal Fine Positioning	
D7	D6	D5	D4	changes the position of the horizontal acquisition window by steps of 2 pixel	Note
1	0	0	0	-16 pixel (-0.8 μ s), most right position of the image	values refer to the undecimated picture
			..		
0	0	0	0	0 pixel, nominal center position	
			..		
0	1	1	1	+14 pixel (0.7 μ s), most left position	

VFP				Vertical Fine Positioning	
D3	D2	D1	D0	changes the position of the vertical acquisition window by steps of 1 line	Note
1	0	0	0	-8 lines, most upper position of the image	values refer to the undecimated picture
			..		
0	0	0	0	0 lines, nominal center position	
			..		
0	1	1	1	+7 lines, most lower position	

Subaddress 04h

DISPSTD		Display Standard
D7	D6	selects the line standard of PIP display
0	0	PIP depends on detected parent standard (multi pip) or inset standard (single pip)
0	1	PIP display is always in 625 line mode
1	0	PIP display is always in 525 line mode
1	1	freeze last detected display standard and size

FREEZE		Freeze Picture
D5		interrupts the inset picture writing and displays still picture
0		live picture
1		still picture

MOSAIC		Mosaic Mode
D4		hides picture details, intended for use with parental control
0		mosaic mode off
1		mosaic mode on

SIZEHOR		Horizontal Size
D3	D2	horizontal decimation
0	0	reduction = 2
0	1	reduction = 3
1	0	reduction = 4
1	1	reduction = 6

SIZEVER		Vertical Size
D1	D0	vertical decimation
0	0	reduction = 2
0	1	reduction = 3
1	0	reduction = 4
1	1	reduction = 6

Subaddress 05h

FPSTD		Force Parent Standard
D7	D6	forces the parent standard to one of the following modes
0	0	auto-detect parent standard
0	1	50Hz/625 lines parent standard forced
1	0	60Hz/525 lines parent standard forced
1	1	freeze last detected standard

PIPBG		PIP Background Display
D5	D4	selects the background display
0	0	PIP visible, no background display
0	1	PIP invisible, background display in PIP
1	0	PIP visible, full screen background display
1	1	PIP invisible, background display in PIP and full screen background

FMACTP	Frame Mode Activation Parent
D3	selects the parent condition for the activation of the frame mode
0	Frame mode active for standard parent video sources only
1	Frame mode active for some nonstandard sources also

HZOOM			Horizontal Zoom
D2	D1	D0	selects the parent (display) clock frequency
0	0	0	27.34 MHz
0	0	1	20.25 MHz
0	1	0	35.27 MHz
0	1	1	25.43 MHz
1	0	0	26.67 MHz
1	0	1	20.63 MHz
1	1	0	34.17MHz
1	1	1	28.04 MHz

Subaddress 06h

HSPINV	Horizontal Sync Pulse Inversion
D7	inverts the polarity of HSP
0	no inversion, raising edge is sync reference
1	HSP inverted, falling edge is sync reference

VSPINV	Vertical Sync Pulse Inversion
D6	inverts the polarity of VSP
0	no inversion, raising edge is sync reference
1	VSP inverted, falling edge is sync reference

VSPNSRQ	Vertical Sync Pulse Noise Reduction
D5	activates automatic V insertion that generates vertical sync pulses in case of missing external VSP
0	on
1	off

VSPDEL					Vertical Sync Pulse Delay	
D4	D3	D2	D1	D0	delay of the vertical sync pulse in steps of 128 parent clocks	Note
0	0	0	0	0	no delay (0)	delay depends on HZOOM
				...		
1	1	1	1	1	maximum delay, 4096 clocks of parent frequency	

Subaddress 07h

FRSEL	Frame Select
D7	selects between the normal frame and the shaded frame
0	normal frame
1	shaded frame with 3D impression

INFRM		Inner Frame activation
D6		actives inner frame (4 pixel width, 2 lines height) for multi-PIP display
0		inner frame off
1		inner frame on

VPSRED		Vertical Picture Size Reduction
D5		reduces vertical picture size to suppress black bars in 16:9 programs
0		no reduction
1		reduction on

FRWIDTH			Frame Width Horizontal
D4	D3	D2	adjusts the horizontal width of the PIP frame in steps of one pixel
0	0	0	no horizontal frame
		...	
1	1	1	7 pixel

FRWIDV		Frame Width Vertical
D1	D0	adjusts the vertical width of the PIP frame in steps of one line
0	0	no vertical frame
	...	
1	1	3 lines

Subaddress 08h

RGBINS		RGB Insertion
D7	D6	controls the insertion of external RGB/YUV sources
0	0	no external insertion possible, FSW input inactive
0	1	external insertion forced (FSW = 1)
1	0	external insertion with FSW possible (priority of FSW input)
1	1	external insertion with FSW possible (priority of PIP)

VERBLK	Vertical Blanking
D5	switches the vertical blanking mode
0	blanking level at DAC outputs only during line-blanking intervals
1	blanking level at DAC outputs during line-blanking intervals and field-blanking intervals, 16 lines following the parent vertical synchronization pulse are blanked

SELDOWN	Select Down
D4	switches the driver type at the output of the SEL pin
0	open source output
1	TTL output

SELDEL				Select Delay
D3	D2	D1	D0	adjusts the delay of select signal
1	0	0	0	-8 clock periods of display clock
			..	
0	0	0	0	0 clock periods of display clock
			..	
0	1	1	1	+7 clock cycles of display clock

Subaddress 09h

POSCOR	Position Correction
D7	activates correction of display position
0	position correction disabled
1	position correction enabled

DISPMOD		Display Mode
D6	D5	selects display modes with equal pictures
0	0	single PiP mode
0	1	3 x1/9 PiP (same content)
1	0	4 x1/16 PiP (same content)
1	1	(reserved)

CLPDEL					Clamping Delay
D4	D3	D2	D1	D0	delay of the clamping pulse for the external RGB/YUV inputs in steps of 8 parent clock periods
0	0	0	0	0	no delay (0)
				...	
1	1	1	1	1	maximum delay, 256 clock periods of parent frequency

Subaddress 0Ah

AGCRES	Automatic Gain Control Reset
D7	resets AGC
0	normal operation
1	reset of AGC

AGCMD		AGC Mode
D6	D5	controls the AGC operation
0	0	evaluation of sync height and ADC overflow
0	1	evaluation of sync height only
1	0	evaluation of ADC overflow only
1	1	AGC fixed (gain depends on AGCVAL)

AGCVAL				Automatic Gain Control Value
D4	D3	D2	D1	AGC value for fixed mode (AGCMD='11')
0	0	0	0	input voltage 0.5 Vpp
			..	
1	0	0	0	input voltage 1 Vpp
			..	
1	1	1	1	input voltage 1.5 Vpp

NOSIGB	No Signal Behavior
D0	controls behavior if synchronization is not possible (no source applied)
0	noisy picture
1	colored background

Subaddress 0Bh

CVBSEL		CVBS Select
D7	D6	select CVBS source
0	0	CVBS1
0	1	CVBS2
1	0	Y/C (Y@CVBS2 / C@CVBS3)
1	1	CVBS3

CLMPID		Clamping Duration
D5	D4	adjusts duration of clamping pulse for ADC (inset channel)
0	0	0.5 μ s
0	1	0.9 μ s
1	0	1.2 μ s
1	1	1.5 μ s

CLMPIST		Clamping Pulse Start
D3	D2	adjusts delay of clamping pulse for ADC referred to the horizontal sync
0	0	1.0 μ s
0	1	1.5 μ s
1	0	2.0 μ s
1	1	2.5 μ s

LMOFST		Luminance Offset
D1	D0	modifies black to blank level offset
0	0	no offset
0	1	offset of 16 LSB
1	0	offset of -8 LSB
1	1	offset of -16 LSB

Subaddress 0Ch

PLLITC		Inset PLL Time Constant
D7	D6	switches the time constant of the inset PLL
0	0	VCR1 (very fast)
0	1	VCR2
1	0	TV1
1	1	TV2 (very slow)

NSRED		Noise Reduction Inset PLL	
D5	D4	selects the level of noise reduction	Note
0	0	noise reduction disabled	
0	1	weak noise reduction	may cause trouble for VCR signals
1	0	heavy noise reduction	
1	1	medium noise reduction	

YCDEL				Y/C Delay
D3	D2	D1	D0	adjusts the delay between luminance and chrominance
1	0	0	0	-8 pixel (-0.4 μ s with respect to undecimated picture)
			..	
0	0	0	0	0 pixel
			..	
0	1	1	1	+7 pixel (0.35 μ s)

Subaddress 0Dh

CSTAND			Color Standard
D7	D6	D5	forces the desired color standard
0	0	0	automatic standard identification
0	0	1	NTSC-M
0	1	0	PAL-N (Argentina)
0	1	1	PAL-M
1	0	0	NTSC44
1	0	1	PAL-B/G/H/I/D
1	1	0	SECAM
1	1	1	PAL60

CSTDEX		Color Standard Exclusion
D4	D3	excludes standards from automatic standard identification
0	0	ignore PAL-M / PAL-N
0	1	ignore SECAM, PAL B/G, PAL60, NTSC4.4
1	0	ignore PAL-M /PAL-N / NTSC-M
1	1	ignore PAL-M / PAL-N / NTSC4.4 / PAL60

LOCKSP	Standard Identification Speed
D2	sets the speed of the color standard recognition
0	medium
1	fast

CKILL		Color Killer Threshold	
D1	D0	damping of color carrier to switch color off	Note
0	0	-30 dB	only valid if color killer active (COLON='0'), values are approximative
0	1	-18 dB	
1	0	-24 dB	
1	1	color always off	

Subaddress 0Eh

BGPOS	Burst Gate Position
D7	adjusts position of burst gate (SECAM only)
0	normal position
1	0.5 μ s delayed

SCMIDL	SECAM Identification Level
D6	changes SECAM identification sensitivity
0	default
1	enhanced

DEEMP		Deemphase Selection
D5	D4	adjusts SECAM deemphase filter
0	0	Filter1
0	1	ITU recommendation
1	0	Filter2
1	1	Filter3

COLON	Color On
D3	disable color killer
0	color killer active
1	color forced on

ACCFIX	Disable Automatic Chroma Control
D2	disables the automatic chroma control (ACC)
0	ACC active
1	ACC fixed (ACC set to nominal value)

CHRBW		Chroma Bandwidth		
D1	D0	PAL	SECAM	remark
0	0	wide	small	adjusts chroma bandwidth
0	1	medium	medium	
1	0	reserved		
1	1	small	wide	

Subaddress 0Fh

IFCOMP		IF-Compensation Filter
D7	D6	equalizes the IF-stage characteristic
0	0	no filtering
0	1	chroma bandpass active
1	0	IF-compensation bandpass (6dB/octave)
1	1	reserved

HUE						Hue Control	
D5	D4	D3	D2	D1	D0	phase of color subcarrier for NTSC	remark
1	0	0	0	0	0	-44.8°	skin color becomes greenish
					..		
0	0	0	0	0	0	0°	
					..		
0	1	1	1	1	1	43.4°	skin color becomes redish

Subaddress 10h

SATNR	Satellite Noise Reduction
D7	stabilizes the horizontal PLL for bad satellite signals („fishes“)
0	disabled
1	enabled

FMACTI	Frame Mode Activation Inset
D6	sets the inset condition for the activation of the frame mode
0	frame mode only active for standard inset video sources
1	enhanced frame mode activation range

CPLLOF	Chroma PLL Off
D5	opens loop of chroma PLL (only for test and servicing)
0	chroma PLL active
1	chroma PLL opened (free running oscillator)

SCADJ					Color Subcarrier Adjustment
D4	D3	D2	D1	D0	color subcarrier frequency fine adjustment
0	0	0	0	0	max. negative deviation (-150 ppm)
				...	
0	0	1	1	1	default (for nominal crystal frequency)
				...	
1	1	1	1	1	max. positive deviation (+310 ppm)

Subaddress 11h

CONADJ				Contrast Adjustment
D7	D6	D5	D4	adjusts the contrast of the picture, acts on OUT1-OUT3
0	0	0	0	nominal contrast
			..	
1	1	1	1	+30% contrast increase

BLKLR				Blanking Level Red
D3	D2	D1	D0	adjusts the pedestal level of the OUT1 channel in steps of 0.5LSB
0	0	0	0	no pedestal
			..	
1	1	1	1	+7.5LSB offset

Subaddress 12h

BRTADJ				Brightness Adjustment
D7	D6	D5	D4	adjusts the brightness of the picture, acts on OUT1-OUT3 in RGB mode (YUVFOR = '0') and on OUT1 in YUV mode (YUVFOR = '1')
0	0	0	0	nominal brightness
			..	
1	1	1	1	+20% brightness increase

BLKLG				Blanking Level Green
D3	D2	D1	D0	adjusts the pedestal level of the OUT2 channel in steps of 0.5LSB
0	0	0	0	no pedestal
			..	
1	1	1	1	+7.5LSB offset

Subaddress 13h

TRIOUT	Tristate Output
D7	sets OUT1-OUT3 to tristate mode (high resistance)
0	normal operation, outputs are active
1	pins OUT1-3 are in tri-state mode

REFINT	Refresh Intervall	
D6	changes the refresh rate of eDRAM	Note
0	normal refresh	let it to this default value
1	fast refresh	

BLKINVR	Blanking Inversion Red	
D5	inverts the sign of the OUT1 channel offset (BLKLR)	
0	offset added during the active picture	
1	offset added during blanking	

BLKINVB	Blanking Inversion Blue	
D4	inverts the sign of the OUT3 channel offset (BLKLB)	
0	offset added during the active picture	
1	offset added during blanking	

BLKLB				Blanking Level Blue
D3	D2	D1	D0	adjusts the pedestal level of the OUT3 channel in steps of 0.5LSB
0	0	0	0	no pedestal
			..	
1	1	1	1	+7.5LSB offset

Subaddress 14h

PKLR								Peak Level Red	
D7	D6	D5	D4	D3	D2	D1	D0	peak to peak output voltage of the OUT1 channel	Note
0	0	0	0	0	0	0	0	0.3 V _{pp}	values refer to contrast (CONADJ) and brightness (BRTADJ) at minimum
							...		
1	1	0	0	0	0	0	0	1 V _{pp}	
							...		
1	1	1	1	1	1	1	1	1.2 V _{pp}	

Subaddress 15h

PKLG								Peak Level Green	
D7	D6	D5	D4	D3	D2	D1	D0	peak to peak output voltage of the OUT2 channel	Note
0	0	0	0	0	0	0	0	0.3 V _{pp}	values refer to contrast (CONADJ) and brightness (BRTADJ) at minimum
							...		
1	1	0	0	0	0	0	0	1 V _{pp}	
							...		
1	1	1	1	1	1	1	1	1.2 V _{pp}	

Subaddress 16h

PKLB								Peak Level Blue	
D7	D6	D5	D4	D3	D2	D1	D0	peak to peak output voltage of the OUT2 channel	Note
0	0	0	0	0	0	0	0	0.3 V _{pp}	values refer to contrast (CONADJ) and brightness (BRTADJ) at minimum
							...		
1	1	0	0	0	0	0	0	1 V _{pp}	
							...		
1	1	1	1	1	1	1	1	1.2 V _{pp}	

Subaddress 17h

MAT		RGB Matrix Select
D7	D6	selects the RGB matrix coefficients for YUV to RGB conversion
0	0	EBU- Matrix
0	1	NTSC-Japan Matrix
1	0	NTSC-USA Matrix
1	1	(reserved)

BGY	Background Color Y
D5-D4	adjusts the Y background color component the values gives the two MSBs of the Y background signal

FRY	Frame Color Y
D3-D0	adjusts the Y frame color component the value gives the 4 MSBs of the Y frame signal

Subaddress 18h

OUTFOR	Output Format
D7	switches between RGB output and YUV output
0	RGB output signals, matrix active
1	YUV output signals

UVPOLAR	UV Polarity
D6	switches between UV or inverted UV output, has no influence in RGB mode
0	+U / +V output
1	-U / -V output

BGU	Background Color U
D5-D4	adjusts the U background color component the values gives the two MSBs of the U background signal

FRU	Frame Color U
D3-D0	adjusts the U frame color component the value gives the 4 MSBs of the U frame signal

Subaddress 19h

BGFRC	Background Frame Color
D6	selects background color table or frame color table for background color
0	background color according to BGY, BGU, BGV
1	background color according to FRY, FRU, FRV

BGV	Background Color V
D5-D4	adjusts the V background color component the values gives the two MSBs of the V background signal

FRV	Frame Color V
D3-D0	adjusts the V frame color component the value gives the 4 MSBs of the V frame signal

Subaddress 1Ah

SATADJ				Color Saturation Adjustment
D7	D6	D5	D4	adjusts the color saturation in steps of x/8
0	0	0	0	no color
			..	
1	0	0	0	nominal saturation
			..	
1	1	1	1	1.875 times saturation

YPEAK			Y Peaking Adjustment
D3	D2	D1	adjusts luminance peaking
0	0	0	no peaking
0	1	1	recommended value
1	1	1	strongest peaking

YCOR	Y Coring Enable
D0	suppresses noise introduced by peaking
0	coring off
1	1LSB coring

Subaddress 1Bh

XDSCLS					XDS Class Select
D7	D6	D5	D4	D3	Closed Caption XDS-Primary Filter (Class)
0	0	0	0	0	transparent, no filtering
1	X	X	X	X	'Current' class selected
X	1	X	X	X	'Future' class selected
X	X	1	X	X	'Channel' class selected
X	X	X	1	X	'Miscellaneous' class selected
X	X	X	X	1	'Public Services' class selected

XDSTPE			XDS Type Select/WSS Field Select			
D2	D1	D0	XDS-Secondary Filter Type	Meaning	WSS field	Note
0	0	0	all	no filtering	0	behavior of these bits depends on selected data-service
0	0	1	05h	program rating	1	
0	1	0	01h, 04h	time information only	0/1	
0	1	1	40h	out of band only	0/1	
1	0	0	01h, 02h, 03h, 04h, 0Dh, 40h	VCR information	0/1	
1	0	1	01h, 04h, 05h	time information and program rating	0/1	
1	1	0	05h, 40h	out of band and program rating	0/1	
1	1	1	01h, 02h, 03h, 04h, 05h, 0Dh, 40h	VCR information and program rating	0/1	

Subaddress 1Ch

UVSEQ	UV Sequence	
D7	changes the UV multiplex sequence	remark
0	U and V are correct	valid only if YUVSEL ='1'
1	U and V are exchanged	

MPIPBG	Multi-PIP Background
D6	selects the background color for multi-PIP mode
0	black
1	same as background color

SERVICE	Data Service Select
D5	selects data service for slicing
0	Closed Caption
1	Widescreen Signalling (WSS)

SELLNR		Select Line Number	
D4	D3	line number of data service field 0 (field1)	remark
0	0	[NTSC] 20 (283), [PAL M] 17 (280)	WSS
0	1	[NTSC] 21 (284), [PAL M] 18 (281)	Closed Caption
1	0	[PAL B/G] 22 (329)	Closed Caption
1	1	[PAL B/G] 23 (330)	WSS

IRQCON			Interrupt Request Pin Configuration	
D2	D1	D0	output of INT pin is:	remark
0	0	0	tri-state (high-Z)	
0	0	1	interrupt, when new data received (neg. polarity)	pulse length is approximately 2 μ s
0	1	0	interrupt, when new data received (pos. polarity)	
0	1	1	equivalent to DATAV for both registers (neg. polarity)	
1	0	0	equivalent to DATAV for both registers (pos. polarity)	
1	0	1	inset V-pulse (neg. polarity)	pulse length is 50ns
1	1	0	inset field	high = first field, low = second field,
1	1	1	inset clamping pulse (neg. polarity)	only for test purpose

Subaddress 1D

PIPBLK		PIP Blank
D2		blanks the current picture by setting it to background color
0		no blank
1		blanks the current selected (WRPOS) PIP

PALIDL		PAL ID Level
D1	D0	sensitivity of identification of PAL/NTSC signals
0	0	high rejection of PAL/NTSC
	..	
1	1	low rejection of PAL/NTSC

Subaddress 1Eh

POSOFV			Position Offset Vertical
D7	D6	D5	vertical position offset in steps of 4 lines
1	0	0	-16 lines
		...	
0	0	0	0 lines
		...	
0	1	1	+12 lines

POSOFH					Position Offset Horizontal
D4	D3	D2	D1	D0	horizontal position offset in steps of 16 pixel
1	0	0	0	0	-256 pixel
				...	
0	0	0	0	0	0 pixel
				...	
0	1	1	1	1	+240 pixel

Subaddress 1Fh

VSHRNK					Vertical Shrink	
D4	D3	D2	D1	D0	changes the vertical size in steps of 2 lines	Note
0	0	0	0	0	no shrink, picture size according to SIZEVER	max. usable value depends on SIZEVER
				...		
1	1	1	1	1	max. possible shrink	

Subaddress 20h

HSHRNK					Horizontal Shrink	
D4	D3	D2	D1	D0	changes the horizontal size in steps of 4 pixel	Note
0	0	0	0	0	no shrink, picture size according to SIZEHOR	max. usable value depends on SIZEVER
				...		
1	1	1	1	1	max. possible shrink	

Subaddress 21h

CLPLEN		Clamping Pulse Length		
D1	D0	clamping pulse length	blanking duration	Note
0	0	5us	10.5us	the clamping pulse length and the blanking is also influenced by the setting of READD and HZOOM
0	1	3.75us	7.9us	
1	0	2.5us	5.2us	
1	1	1.25us	2.6us	

Subaddress 22h

PIPHLT	PIP Highlighting
D7	highlights the current selected (WRPOS) PIPr
0	no highlighting
1	highlighting the PIP

ABRTHD				Automatic Brightness Reduction Threshold
D6	D5	D4	D3	threshold adjustment for reduction of luminance magnitude
0	0	0	0	ABR off
0	0	0	1	ABR threshold at luminance value of 240
			..	
1	1	1	1	ABR threshold at luminance value of 180

ABRSPD			Automatic Brightness Reduction Speed
D2	D1	D0	speed adjustment for reduction of luminance magnitude
0	0	0	2 fields
		...	
1	1	1	16 fields

Subaddress 23h

INFRMOD	Inner Frame Modification
D7	modifies the look of the frame for dual-PiP applications
0	inner frame suited for usage of single SDA 9589X/9489X applications
1	inner frame suited for usage of dual SDA 9589X/9489X applications

DISPMOD					Display Mode	
D6	D5	D4	D3	D2	selects the single PIP modes, Multi-PIP modes or Double-Window mode	Note
0	0	0	0	0	Single PiP mode	see table 4-11 for description of modes
				...		
1		0	1	0	OSD only mode	

WIPESP		Wipe Speed
D1	D0	selects the period for opening/closing the PIP window
0	0	wipe off
0	1	1/3 second
1	0	2/3 second
1	1	1 second

Subaddress 24h

CZMEN	Continuous Zoom Enable
D7	controls the update of the picture size
0	delayed execution of HDEC/VDEC/HSRKNK/VSHRKNK update
1	picture size will be updated

CZMSP		Continuous Zoom Speed	
D6	D5	speed setting for continuous zooming	Note
0	0	no zoom	1 step means 20 pixel and 8 lines (PAL) or 6 lines (NTSC) decrement or increment
0	1	1 step per 1 fields	
1	0	1 step per 2 fields	
1	1	1 step per 4 fields	

WRPOS				Write Position	
D3	D2	D1	D0	position of the current written picture	Note
0	0	0	0	first writing position = first picture	number of last valid writing position depends on display mode (DISPMOD)
0	0	0	1	second writing position	
			..		
1	0	0	1	maximum writing position	

Subaddress 25h

CHRFRC	Character Frame Color
D7	modifies the character color
0	character luminance table used
1	frame color table used

CHRDHW	Character Double Height and Width
D6	doubles the characters' height and width
0	normal height and width
1	double height and width

CHRY		Character Luminance	
D5	D4	character luminance level (IRE)	Note
0	0	60	valid only if CHRFRC = '0', character chrominance is 0 IRE
0	1	70	
1	0	80	
1	1	90	

CHRBGY		Character Background Luminance
D3	D2	character background luminance level (IRE)
0	0	10
0	1	20
1	0	30
1	1	40

CHRBGON		Character Background On	
D1	D0	defines the characters' background	Note
0	0	no character background (transparent mode)	
0	1	character background (dependent on CHRBGY)	
1	0	semi-transparent mode (black&white)	not possible in case of active background in PiP
1	1	semi-transparent mode (colored)	

Subaddress 26h

OSDON	OSD On
D7	switches OSD on
0	OSD off
1	OSD on

CHRADR							Character Address		
D6	D5	D4	D3	D2	D1	D0	No. picture	No. character	Note
0	0	0	0	0	0	0	0	0	will be auto-incremented with every write access to CHRCOD
0	0	0	0	0	0	1	0	1	
						
0	0	0	0	1	0	0	0	4	
0	0	0	1	0	0	1	1	1	
						
1	0	1	1	1	0	0	11	4	

Subaddress 27h

CHRCLR	Character Clear
D7	resets all characters to 'blank' character
0	no blank
1	character reset

CHRCOD	Character Code
D6-D0	character code, see Appendix

Subaddress 28h

FRMMD	Frame Mode Indication
D7	PIP displays field or frame mode
0	field mode, one field is repeated twice
1	frame mode, both fields are displayed

PIPSTAT		PIP Status
D6		indication of visibility of PIP, corresponds to PIPON
0		PIP off
1		PIP on

SYNCST		Inset Synchronization Status
D5	D4	inset synchronization PLL is
0	0	not locked to CVBS signal
0	1	
1	0	locked to CVBS signal (60 Hz)
1	1	locked to CVBS signal (50 Hz)

CKSTAT		Color Killer Status
D3		chroma is
0		off
1		on

STDET			Standard Detection
D2	D1	D0	detected color standard
0	0	0	nonstandard or standard not detected
0	0	1	NTSC-M
0	1	0	PAL-M
0	1	1	NTSC44
1	0	0	PAL60
1	0	1	PAL-N
1	1	0	SECAM
1	1	1	PAL-B/G

Subaddress 2Ah

DATAA	First Data Byte
D7-D0	first word of sliced data, D7 = MSB, D0 = LSB

Subaddress 2Bh

DATAB	Second Data Byte
D7-D0	second word of sliced data, D7 = MSB, D0 = LSB

Subaddress 2Ch

DEVICE		Device Identification
D5	D4	Micronas PIP IC
0	0	SDA 9488X (PIP IV Basic)
0	1	SDA 9489X (PIP IV Advanced)
1	0	SDA 9588X (OCTOPUS)
1	1	SDA 9589X (SOPHISTICUS)

PRNSTD	Parent Standard Detection
D3	status of parent (display) standard detection
0	60Hz field frequency detected
1	50Hz field frequency detected

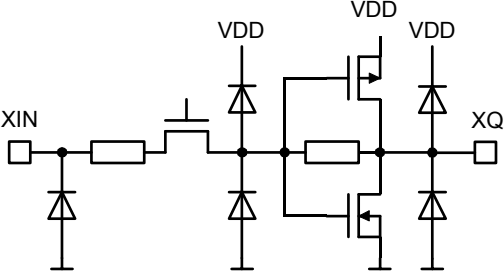
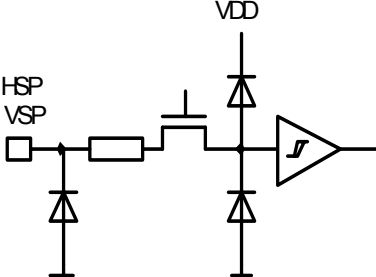
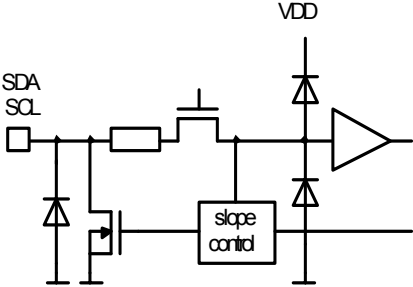
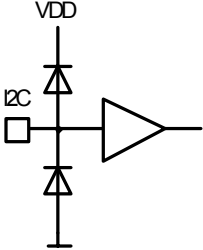
PALID	PAL Identification	
D2	identification of PAL signal	Note
0	NTSC signal	not valid if STDET= '000'
1	PAL signal	

DATAV	Data Valid
D1	new data indication, used for data flow control (polling mode)
0	data read via I ² C or no data available
1	new data received and available in DATAA and DATAB

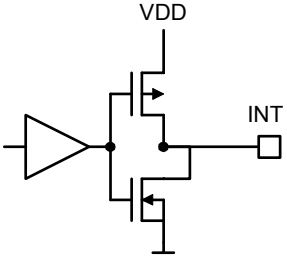
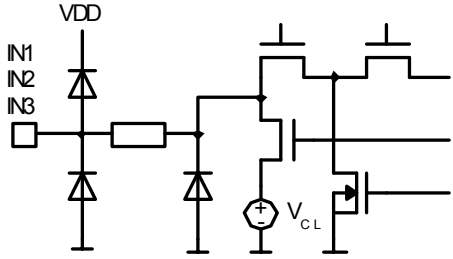
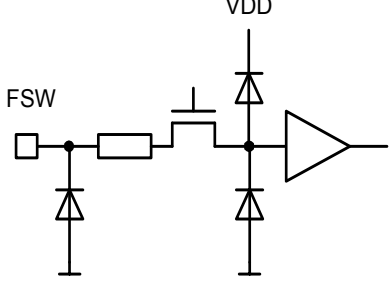
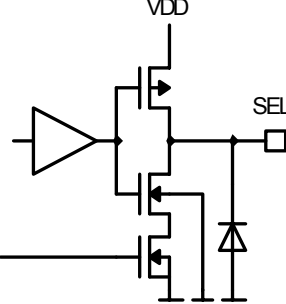
SLFIELD	Sliced Data Field Number
D0	DATAA and DATAB are from
0	first field
1	second field

Pin Description

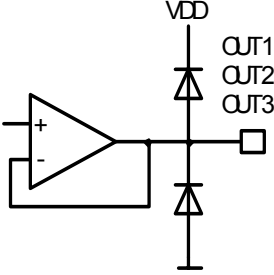
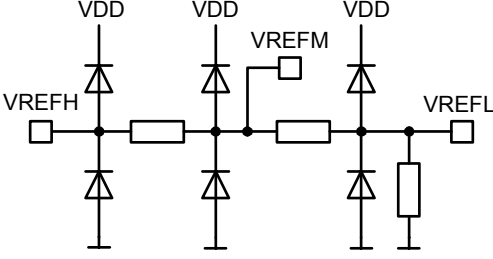
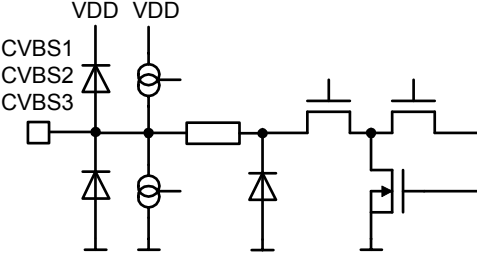
7 Pin Description

pin	schematic	remark
<p>1 (XIN) 2 (XQ)</p>		<p>crystal oscillator, input can be used for external clocking</p>
<p>3 (HSP) 4 (VSP)</p>		<p>schmitt-trigger input with high hysteresis, for best jitter performance use pulses with steep slopes</p>
<p>5 (SDA) 6 (SCL)</p>		<p>low-side driver not used for SCL, slope of acknowledge is limited</p>
<p>9 (I2C)</p>		<p>I2C address selection, only static switch supported</p>

Pin Description

pin	schematic	remark
10 (INT)		
11 12 13 (IN1 IN2 IN3)		clamped RGB/YUV video inputs, if not used let open or connect with 10nF to ground
14 (FSW)		fast switch input
15 (SEL)		low-side driver can be disabled (open source mode)

Pin Description

pin	schematic	remark
16 (OUT3) 17 (OUT2) 18 (OUT1)		RGB/YUV video outputs
21 (VREFH) 25 (VREFL) 27 (VREFM)		reference voltage for ADC and DAC
24 (CVBS3) 26 (CVBS2) 28 (CVBS1)		clamped video inputs

Absolute Maximum Ratings

8 Absolute Maximum Ratings

Parameter	Symbol	Limit Values		Unit	remark
		min.	max.		
Ambient Temperature	T_A	0	70	°C	
Storage Temperature	T_{stg}	-55	125	°C	
Junction Temperature	T_j		125	°C	
Soldering Temperature	T_{sold}		260	°C	duration <10s
Input Voltage	V_i	-0.3V	$V_{DD}+0.3V$	1	except SDA, SCL, HSP, VSP
	V_i	-0.3	5.5	V	SDA, SCL, HSP, VSP only
Output Voltage	V_Q	-0.3V	$V_{DD}+0.3V$	1	except SDA
	V_Q	-0.3	5.5	V	SDA only
Supply Voltages	V_{DD}	-0.3	3.6	V	
Supply Voltage Differentials		-0.25	0.25	V	
Total Power Dissipation	P_{tot}		0.86	W	
Latch-Up Protection	I_{LU}	-100	100	mA	
ESD robustness	$V_{ESD,HBM}$	-2000	2000	V	HBM: 1.5kΩ, 100pF

All voltages listed are referenced to ground (0V, V_{SS}) except where noted.

Stresses above those listed here may cause permanent damage to the device. Exposure to absolute maximum rating conditions for extended periods may affect device reliability. Maximum ratings are absolute ratings; exceeding only one of these values may cause irreversible damage to the integrated circuit.

Recommended Operating Range

9 Recommended Operating Range

Parameter	Symbol	Limit Values			Unit	Remark
		min.	typ.	max.		
Supply Voltages	V_{DDXX}	3.15	3.3	3.45	V	
Ambient Temperature	T_A	0	25	70	°C	

Main horizontal / vertical Sync Inputs: VSP, HSP

HSP Signal Frequency	f_{PH}	15.000	15.625	16.250	kHz	$1f_H$ mode
HSP Signal Frequency	f_{P2H}	30.000	31.250	32.500	kHz	$2f_H$ mode
HSP Signal Frequency	f_{P2H}	11.7	25.2	48	kHz	VGA mode
HSP Signal Rise Time	t_r			100	ns	noise-free transition
HSP Signal High Time	t_{HH}	200			ns	
HSP Signal Low Time	t_{LH}	900			ns	
VSP Signal Frequency	f_{PV}		50/60		Hz	
VSP Signal Frequency	f_{PV}		100/120		Hz	scan rate conversion
VSP Signal High Time	t_{HV}	200			ns	
VSP Signal Low Time	t_{LV}	200			ns	

Inset Input: CVBS1, CVBS2, CVBS3

Horizontal Frequency	f_H		15.734		kHz	60 Hz input
Horizontal Frequency	f_H		15.625		kHz	50 Hz input
Amplitude of synchronization pulse	V_{sync}		300		mV	
length of horizontal synchronization puls	t_{DH}		4.7		μ s	
length of vertical synchronization puls	t_{DV}		22		μ s	
chroma amplitude	A_{CHR}		300		mV	burst
Input Coupling Capacitors	C_{CLI}	2.2	10	100	nF	necessary for proper clamping
CVBS Source Resistance	R_{SRCI}		100	500	Ω	

Recommended Operating Range

Parameter	Symbol	Limit Values			Unit	Remark
		min.	typ.	max.		
Input Voltage Range at inputs CVBS1-3	V_i	0.5	1	1.5	V	dep. on AGC setting

Reference Voltages: VREFL, VREFM, VREFH

Reference Voltage Low	V_{REFL}	1.05	1.11	1.17	V	
Reference Voltage Middle	V_{REFM}	1.81	1.91	2.00	V	
Reference Voltage High	V_{REFH}	3.15	3.3	V_{DDA1}	V	

RGB/YUV Switch: IN1, IN2, IN3, FSW

Input Coupling Capacitors	C_{CLS}	2.2	10	100	nF	necessary for proper clamping
Source Resistance	R_{SRCS}		100	500	Ω	
Input Voltage Range at inputs IN1-3	V_{IS}	0.3	1	1.6	V	
Input Voltage Range at inputs FSW	V_{IF}	0.3	1	1.6	V	

I²C Address: I2C

Input Voltage Range for Address	V_{SA1}	0		0.8	V	
Input Voltage Range for Address	V_{SA2}	2.8		V_{DDD}	V	

Fast I²C Bus (All values are referred to $\min(V_{IH})$ and $\max(V_{IL})$)

This specification of the bus lines need not be identical with the I/O stages specification because of optional series resistors between bus lines and I/O pins.

SCL Clock Frequency	f_{SCL}	0		400	kHz	
Inactive Time Before Start Of Transmission	t_{BUF}	1.3			μ s	
Set-Up Time Start Condition	$t_{SU;STA}$	0.6			μ s	
Hold Time Start Condition	$t_{HD;STA}$	0.6			μ s	
SCL Low Time	t_{LOW}	1.3			μ s	

Recommended Operating Range

Parameter	Symbol	Limit Values			Unit	Remark
		min.	typ.	max.		
SCL High Time	t_{HIGH}	0.6			μs	
Set-Up Time DATA	$t_{\text{SU;DAT}}$	100			ns	
Hold Time DATA	$t_{\text{HD;DAT}}$	0		0.9	μs	
SDA/SCL Rise/Fall Times	$t_{\text{R}}, t_{\text{F}}$	20+\$		300	ns	$\$=0.1C_{\text{b}}/\text{pF}$
Set-Up Time Stop Condition	$t_{\text{SU;STO}}$	0.6			μs	
Capacitive Load/Bus Line	C_{b}			400	pF	

I²C Bus Inputs/Output: SDA, SCL

High-Level Input Voltage	V_{IH}	3V		5.5V	1	also for SDA/SCL input stages
Low-Level Input Voltage	V_{IL}	-0.25V		1.5	V	
Spike Duration At Inputs		0	0	50	ns	
Low-Level Output Current	I_{OL}			6	mA	

Digital To Analog Converters (7-bit):OUT1, OUT2, OUT3

Load resistance	R_{L}	10			$\text{k}\Omega$	
Load capacitance	C_{L}			30	pF	

Crystal Specification: XIN, XQ

Frequency	f_{xtal}	20.248	20.25	20.252	MHz	deviation outside this range will cause color decoding failures
Maximum Permissible Frequency Deviation	$\frac{\Delta f_{\text{max}}}{f_{\text{xtal}}}$	-100		100	10^{-6}	deviation outside this range will cause color decoding failures
Recommended Permissible Frequency Deviation	$\Delta f/f_{\text{xtal}}$	-40	0	40	10^{-6}	

Recommended Operating Range

Parameter	Symbol	Limit Values			Unit	Remark
		min.	typ.	max.		
Load Capacitance	C_L	12	27	39	pF	
Series resonance resistance	R_S		25		Ω	
Motional capacitance	C_1		27		fF	
Parallel capacitance	C_0		7		pF	

In the operating range the functions given in the circuit description are fulfilled.

Characteristics

10 Characteristics

(Assuming Recommended Operating Conditions)

Parameter	Symbol	Limit Values			Unit	Remark
		min.	typ.	max.		
Average total supply current	I_{DDtot}	180	210	240	mA	

All Digital Inputs (TTL, I²C)

Input Capacitance	C_I		7		pF	
Input Leakage Current		-10		10	μ A	incl. leakage current of SDA output stage

SEL

High-Level Output Voltage	V_{OH}	2.4 V		V_{DD}	V	$I_{OH}=-200\mu$ A
High-Level Output Voltage	V_{OH}	1.5V		V_{DD}	V	$I_{OH}=-4.5$ mA
Low-Level Output Voltage	V_{OL}			0.4	V	$I_{OL}=1.6$ mA, only valid if bit SELDOWN=1

FSW

Low-Level Input Voltage	V_{IL}	-0.25		0.4	V	
High-Level Input Voltage	V_{IH}	0.9		$V_{DD}+0.5$	V	
Delay FSW in -> SEL out			10		ns	

I²C Inputs: SDA/SCL

Schmitt Trigger Hysteresis	V_{hys}	0.1	0.2	0.5	V	not tested
----------------------------	-----------	-----	-----	-----	---	------------

I²C Input / Output: SDA (Referenced to SCL; Open Drain Output)

Low-Level Output Voltage	V_{OL}			0.4	V	$I_{OL}=3$ mA
Low-Level Output Voltage	V_{OL}			0.6	V	$I_{OL}=\max$

Characteristics

Parameter	Symbol	Limit Values			Unit	Remark
		min.	typ.	max.		
Output Fall Time from min(V_{IH}) to max(V_{IL})	t_{OF}	20+0.1* C_b /pF		250	ns	$10\text{pF} \leq C_b \leq 40\text{pF}$

Analog Inputs CVBS1, CVBS2, CVBS3

CVBS Input Leakage Current	I_L	-100		100	nA	clamping inactive
CVBS Input Capacitance	C_I		7		pF	
Input Clamping Error	ΔCLE	-1		1	LSB	settled state
Input Clamping Current	$ \bar{I}_{CLP} $	43		326	μA	dependent on clamping error
max. Input Clamping Current deviation	$ I_{CLPx} / I_{CLP} $	-40		40	%	
Reference Voltage Difference	$V_{REFH} - V_{REFL}$	0.5		1.5	V	$V_{DDA1} = 3.3\text{V}$
D.C. Differential Nonlinearity	DNL	-1		1	LSB	$V_{REFH} - V_{REFL} = \text{max}$
Crosstalk between CVBS Inputs	CT		-50		dB	

Digital To Analog Converters (7-bit): Outputs OUT1, OUT2, OUT3

D.C. Differential Nonlinearity	DNLE	-0.5		0.5	LSB	
Full Range Output Voltage	V_{OL}	0.3			V	CON, UAMP, VAMP, YAMP = 0
Full Range Output Voltage	V_{OH}			1.6	V	CON, UAMP, VAMP, YAMP = max

Characteristics

Parameter	Symbol	Limit Values			Unit	Remark
		min.	typ.	max.		
Output Voltage	V_O	0.9	1	1.1	V	CON, UAMP, VAMP, YAMP = default, VREF = const.
Deviation of OUT1-3 (matching)	M_{CH}	-3		3	%	
Contrast Increase	ΔCON		30		%	
Output Amplitude Ratio ($U_{OH}-U_{OL}$)/ U_{OL}	ΔAMP		400		%	
Brightness Increase	ΔBRT			15	LSB	
Pedestal Level variation	ΔPED			+/- 7.5	LSB	

RGB / YUV switch; IN1, IN2, IN3

Input Voltage Range	ΔV_I			1.2	Vpp	
Bandwidth (-3dB)	BW		25		MHz	$R_L > 10k\Omega$; $C_L = 20pF$
Gain	G	0.9		1.1		
Gain Difference RGB	ΔG			3	%	f<4MHz
Crosstalk Between Inputs	CT_I			-40	dB	f=5MHz, (R-G-B, U- V)
Crosstalk Between Inputs	CT_I			-45	dB	f=5MHz, (Y-UV)
Isolation (off state)	D	45			dB	f=5MHz
Clamping Level Difference at Output	$\Delta CLPE$			15	mV	between external and internal source

Colordecoder/Synchronization and Luminance Processing

Horizontal PLL pull-in- range	$\Delta f_H/f_H$	13.3		17.4	kHz	VCR1 and VCR2
----------------------------------	------------------	------	--	------	-----	------------------

Characteristics

Parameter	Symbol	Limit Values			Unit	Remark
		min.	typ.	max.		
Horizontal PLL pull-in-range	$\Delta f_{HF}/f_H$	13.3		17.4	kHz	TV1 and TV2
Amplitude of synchronization pulse	V_{sync}	60		600	mV	AGC set to 1.2 V input signals
length of horizontal synchronization pulse	t_{DH}	1.8			μs	
length of vertical synchronization pulse	t_{DV}	22			μs	
ACC range	CR_{ACC}	-24		+6	dB	
AGC range	CR_{AGC}	-7.5		+2	dB	
Chroma PLL pull-in-range	Δf_{SC}		+/- 500		Hz	nominal crystal frequency

Data slicer

Data level	V_D	266	350	434	mV	CC
Data height	ΔV_D	280	350	420	mV	CC
Eye Height	EH	26.6			%	
Co Channel Distortion	CD25			174	mV	25kHz
Co Channel Distortion	CD50			155	mV	50kHz
Max. permissible Noise	N			20	dB	

The listed characteristics are ensured over the operating range of the integrated circuit. Typical characteristics specify mean values expected over the production spread. If not otherwise specified, typical characteristics apply at $T_A = 25^\circ C$ and the given supply voltage.

11 Diagrams

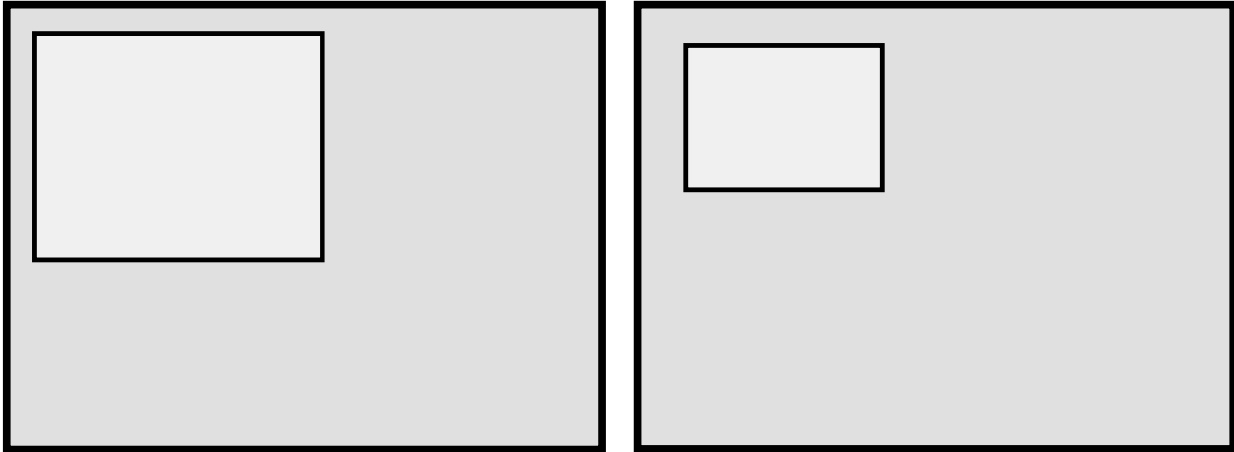


Figure 11-1 Display mode 0 with picture sizes 1/4 and 1/9

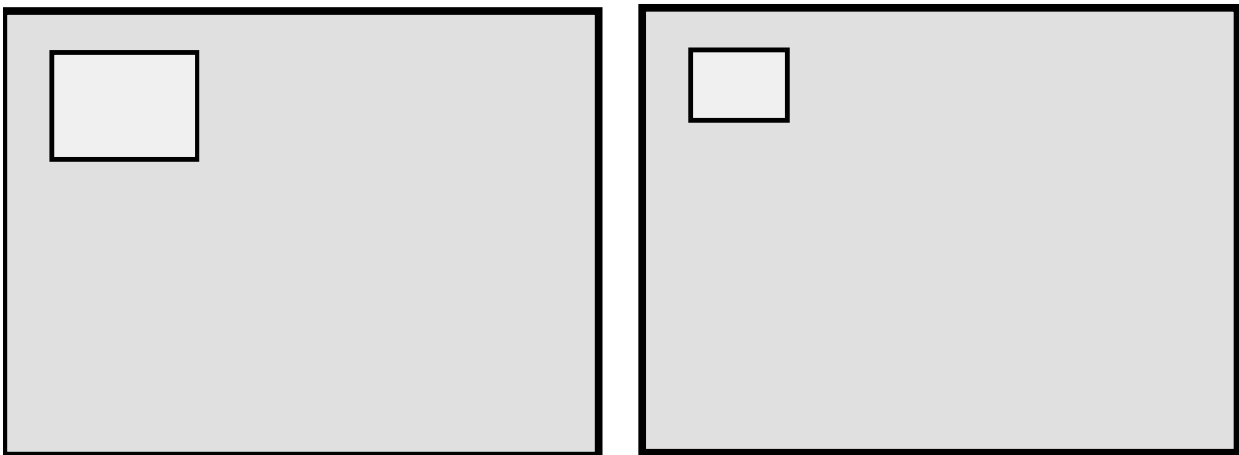


Figure 11-2 Display mode 0 with picture sizes 1/16 and 1/36

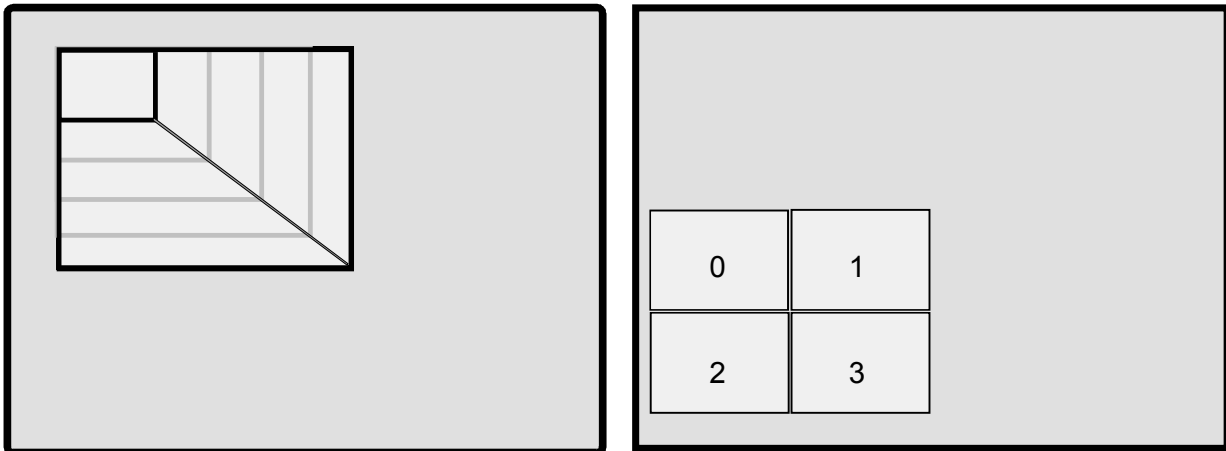


Figure 11-3 Display mode 0 (with scaling) and display mode 11

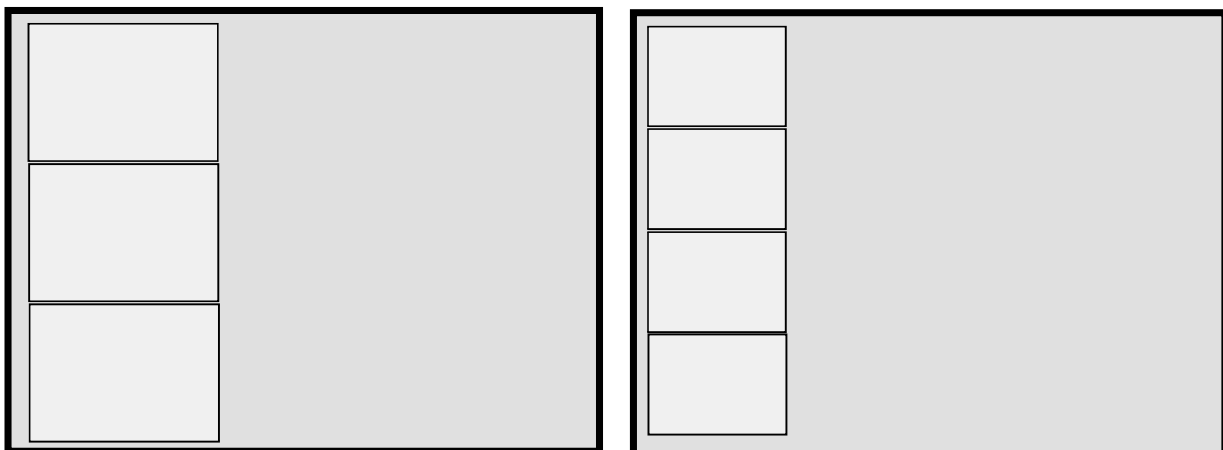


Figure 11-4 Display mode 2 and 3 (all pictures with same content)

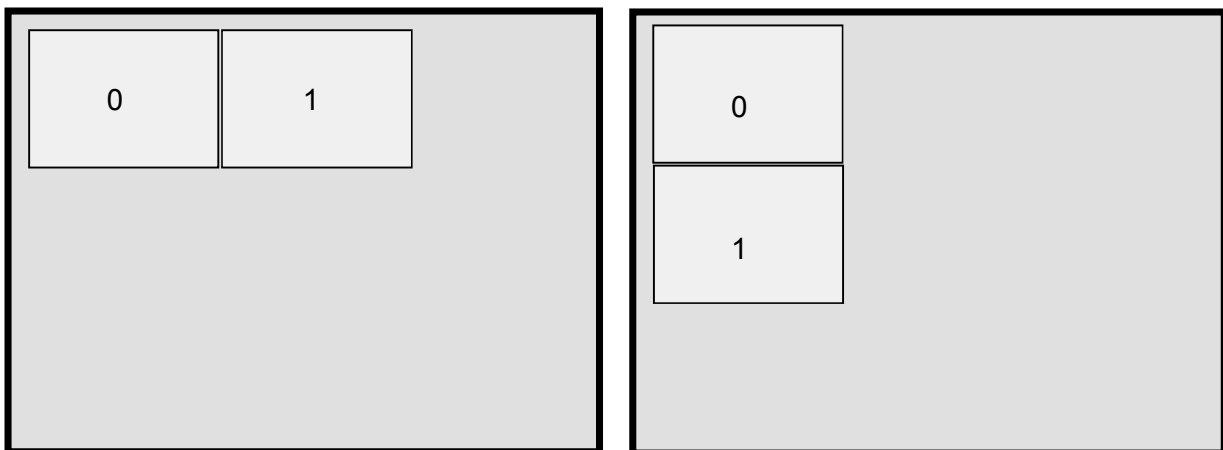


Figure 11-5 Display modes 4 and 5

Diagrams

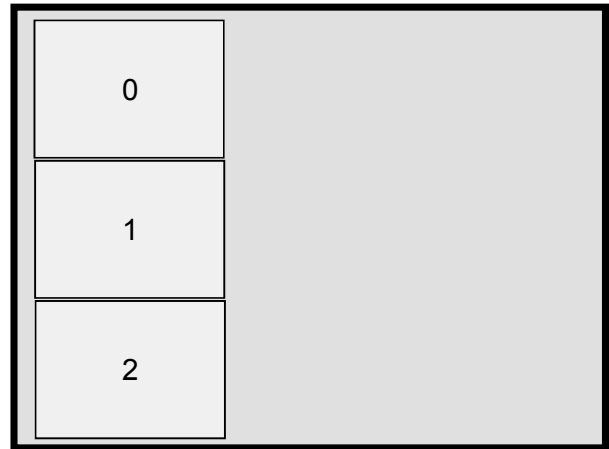
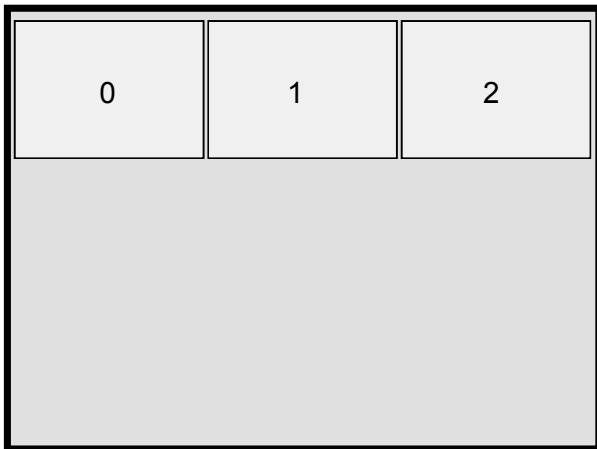


Figure 11-6 Display modes 6 and 7

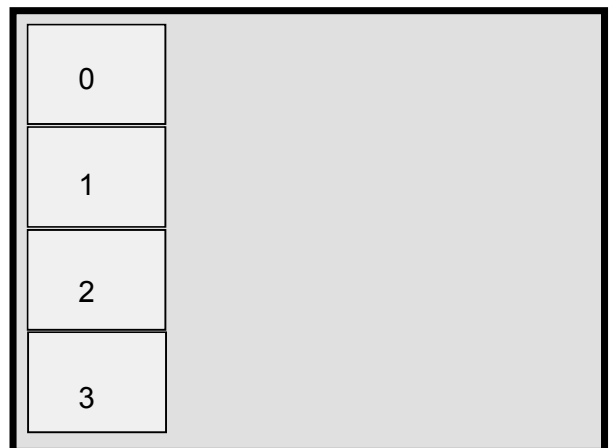
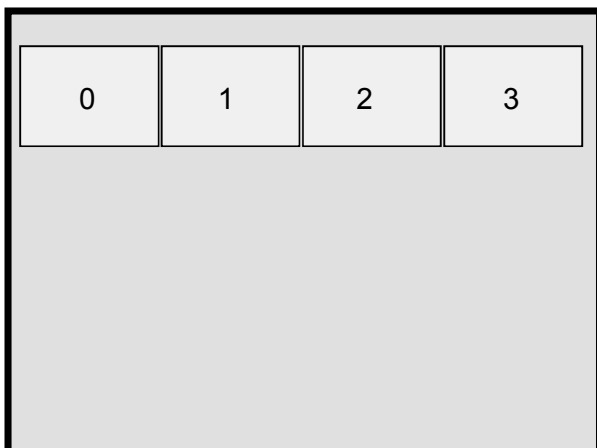


Figure 11-7 Display modes 8 and 12

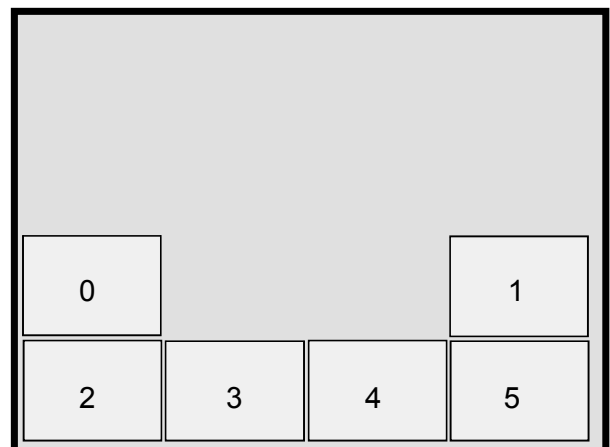
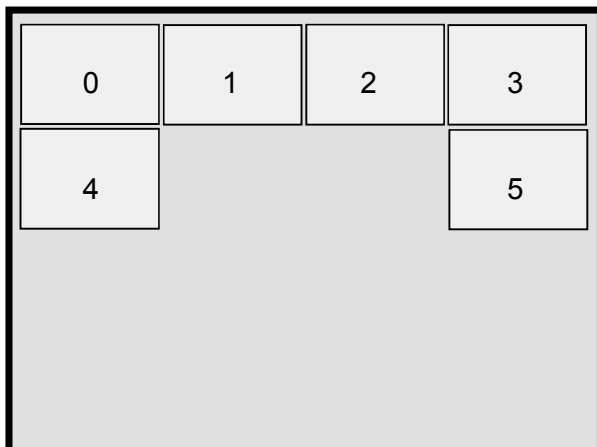


Figure 11-8 Display modes 9 and 10

Diagrams

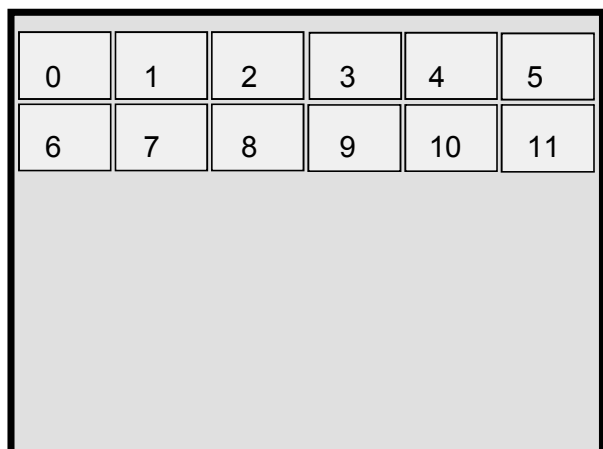
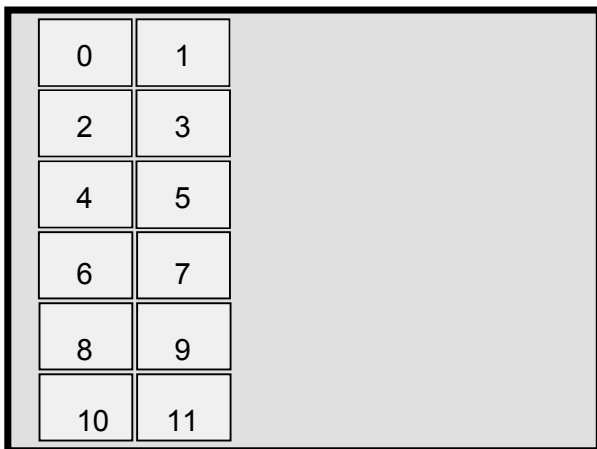


Figure 11-9 Display modes 13 and 14

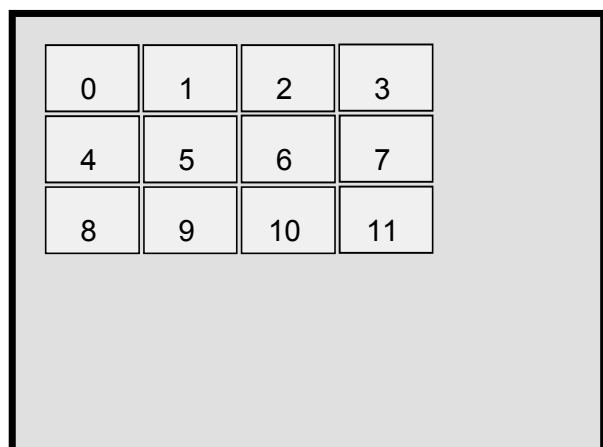
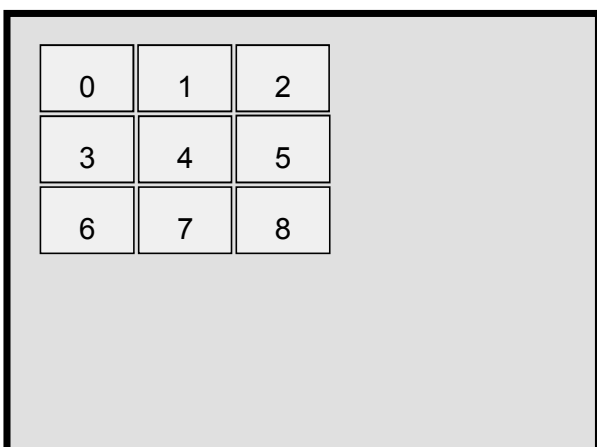


Figure 11-10 Display modes 15 and 16

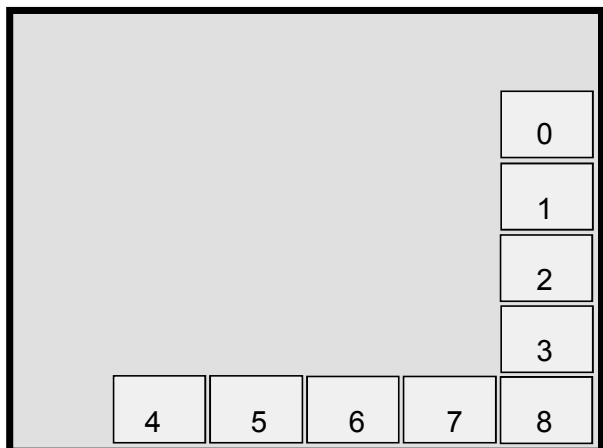
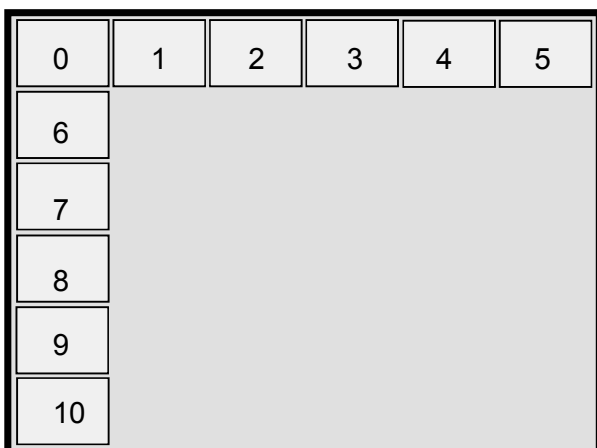
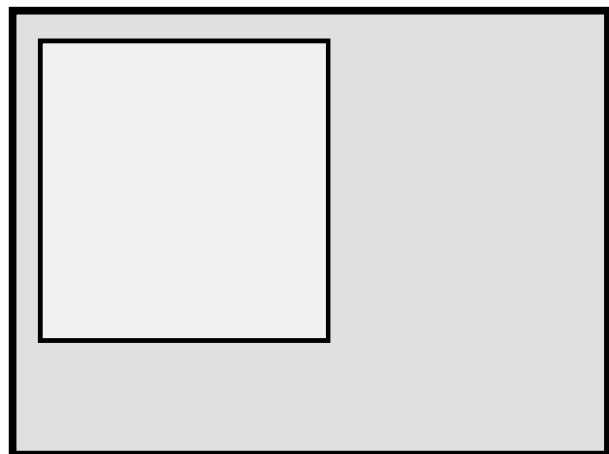


Figure 11-11 Display modes 17 and 18

Diagrams



Display mode 20 (Double Window 1) and 19 (Double Window 1.5)

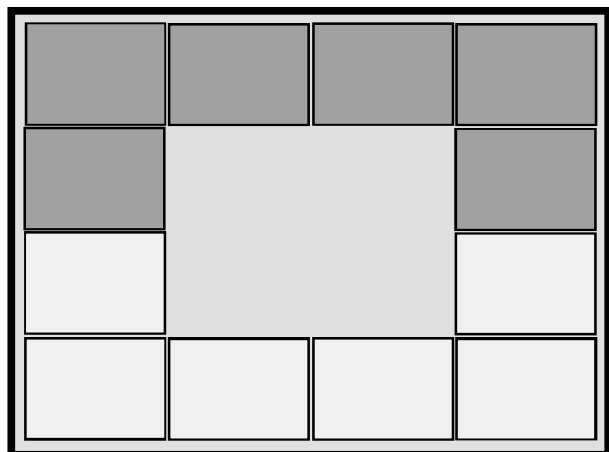
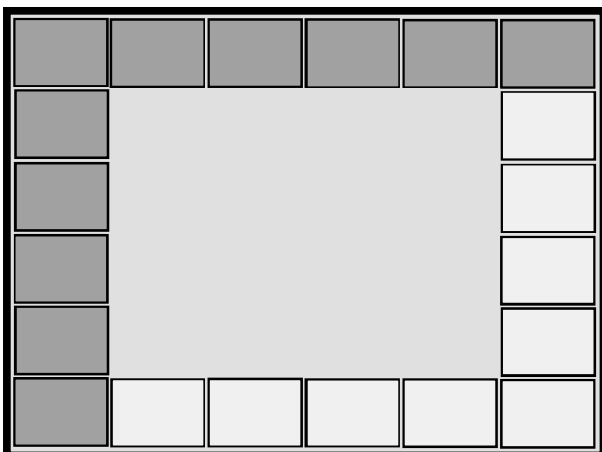


Figure 11-12 Combination of display modes 17/ 18 and 9/ 10 (dual PiP application)

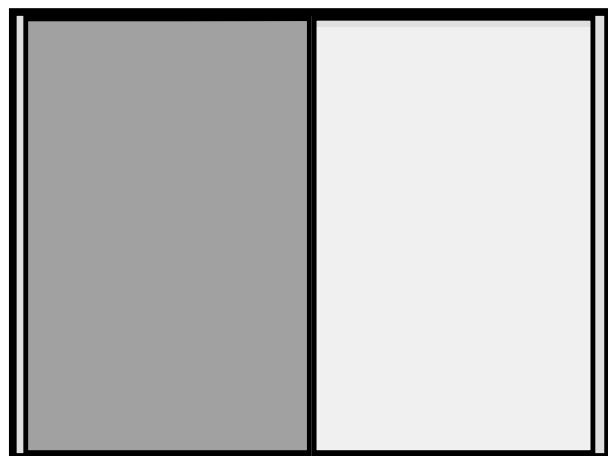
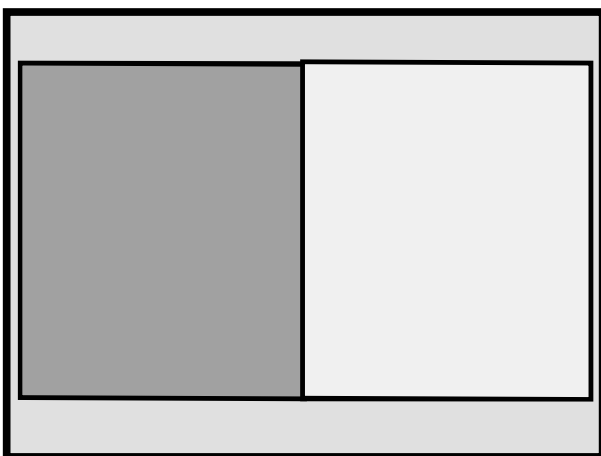


Figure 11-13 Display modes 19 and 20 (dual PiP application)

Diagrams

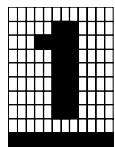
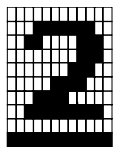
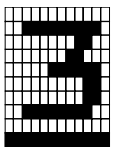
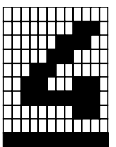
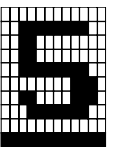
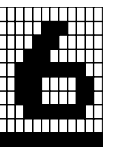
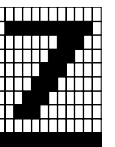
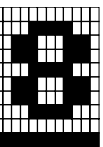
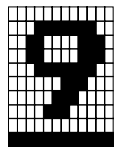
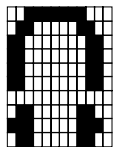
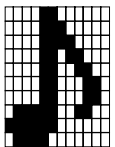
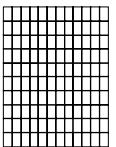
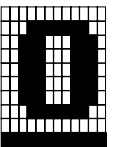
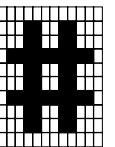
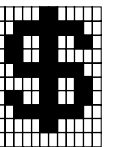
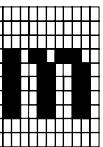
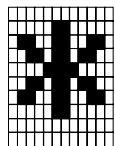
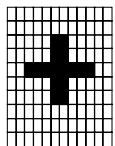
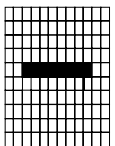
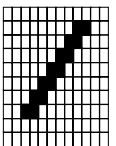
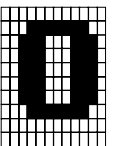
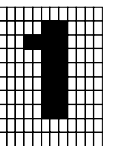
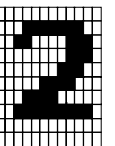
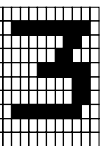
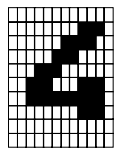
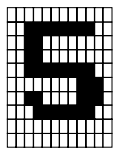
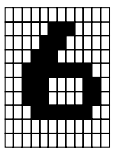
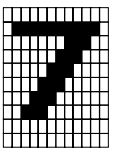
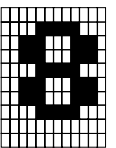
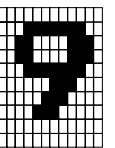
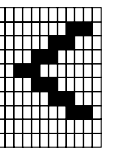
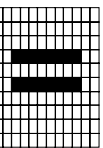
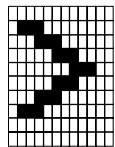
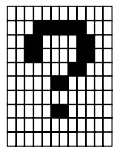
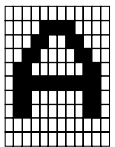
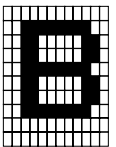
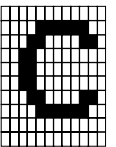
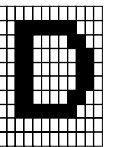
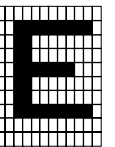
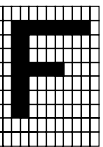
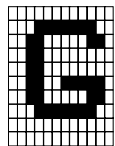
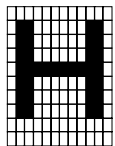
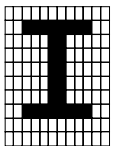
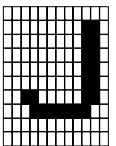
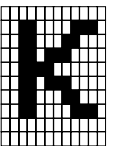
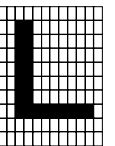
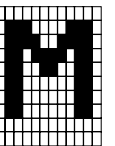
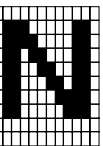
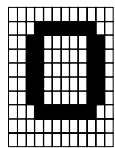
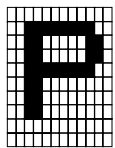
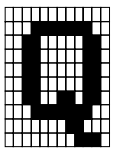
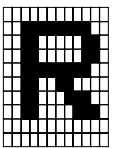
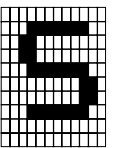
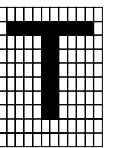
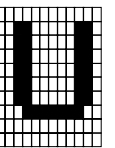
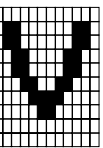
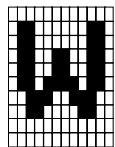
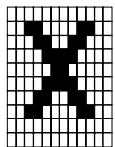
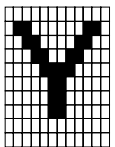
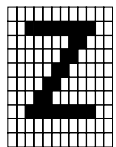
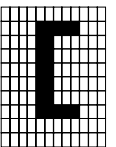
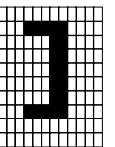
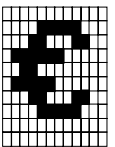
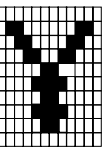
							
000001=01	000010=02	000011=03	0000100=04	0000101=05	0000110=06	0000111=07	0001000=08
							
0001001=09	0001010=0A	0001011=0B	0100000=20	0100001=21	0100011=23	0100100=24	0100101=25
							
0101010=2A	0101011=2B	0101101=2D	0101111=2F	0110000=30	0110001=31	0110010=32	0110011=33
							
0110100=34	0110101=35	0110110=36	0110111=37	0111000=38	0111001=39	0111100=3C	0111101=3D
							
0111110=3E	0111111=3F	1000001=41	1000010=42	1000011=43	1000100=44	1000101=45	1000110=46
							
1000111=47	1001000=48	1001001=49	1001010=4A	1001011=4B	1001100=4C	1001101=4D	1001110=4E
							
1001111=4F	1010000=50	1010001=51	1010010=52	1010011=53	1010100=54	1010101=55	1010110=56
							
1010111=57	1011000=58	1011001=59	1011010=5A	1011011=5B	1011101=5D	1011110=5E	1011111=5F

Figure 11-14 OSD Character Set

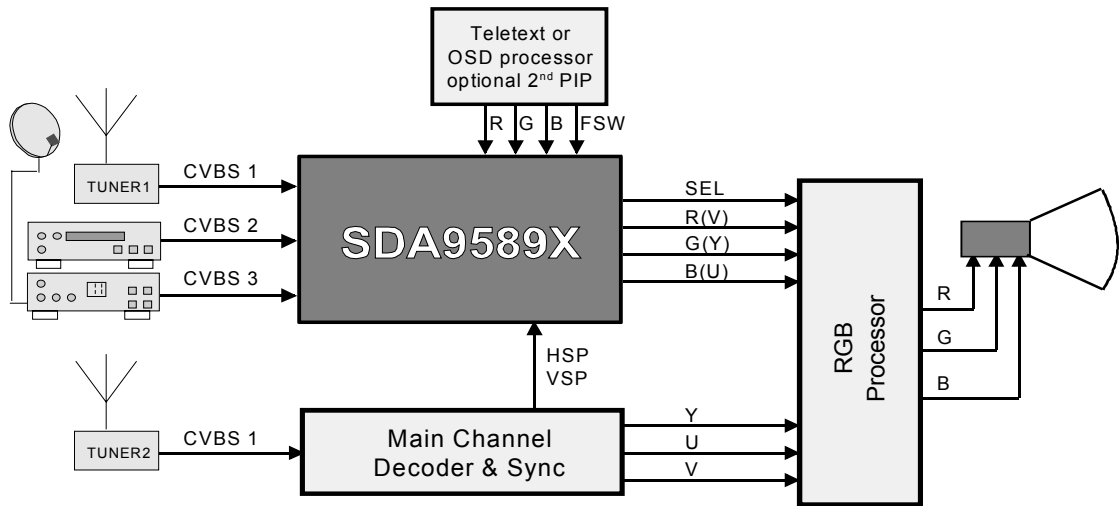


Figure 11-15 General Application with 3 CVBS sources and Teletext-Processor

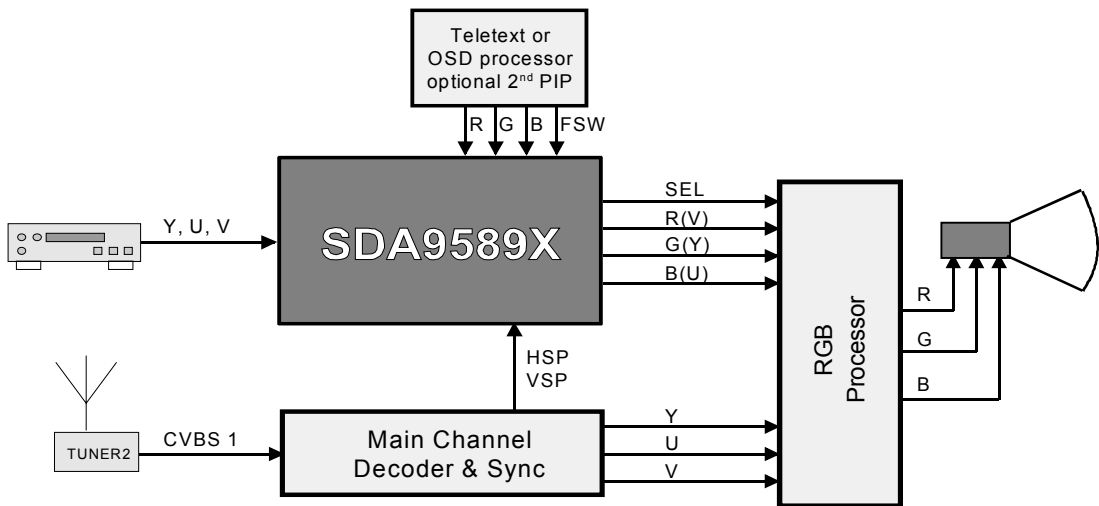


Figure 11-16 General Application with YUV source from DVD

Diagrams

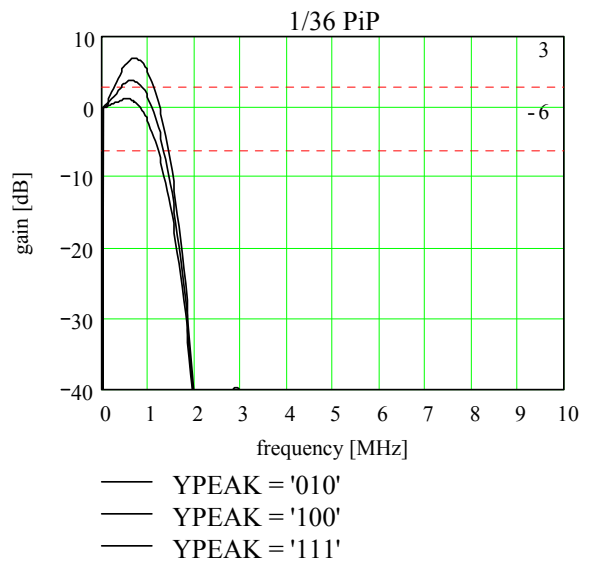
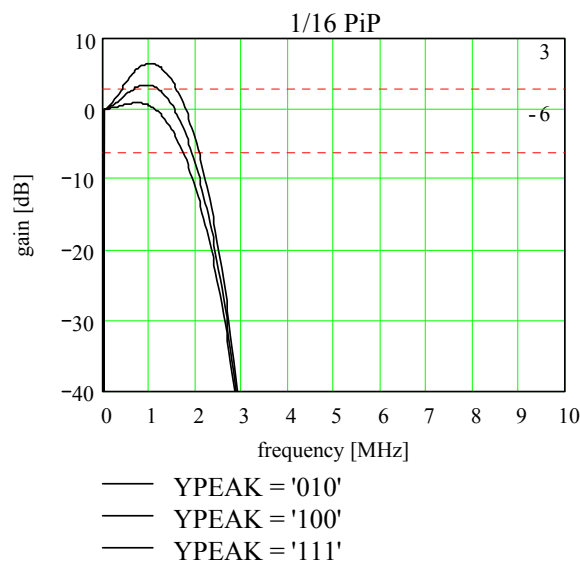
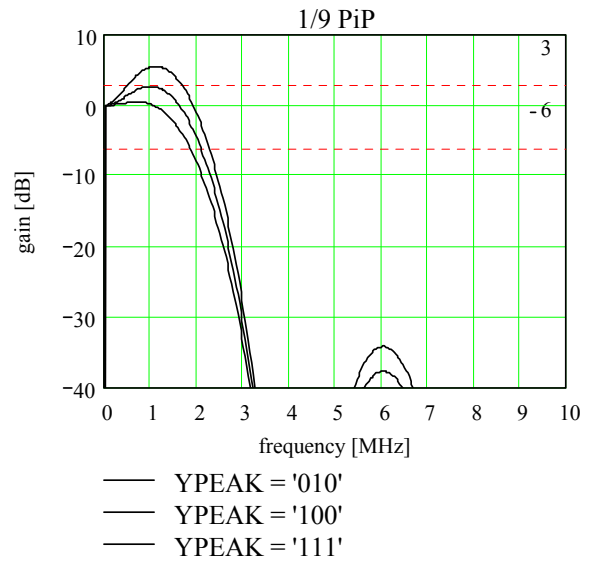
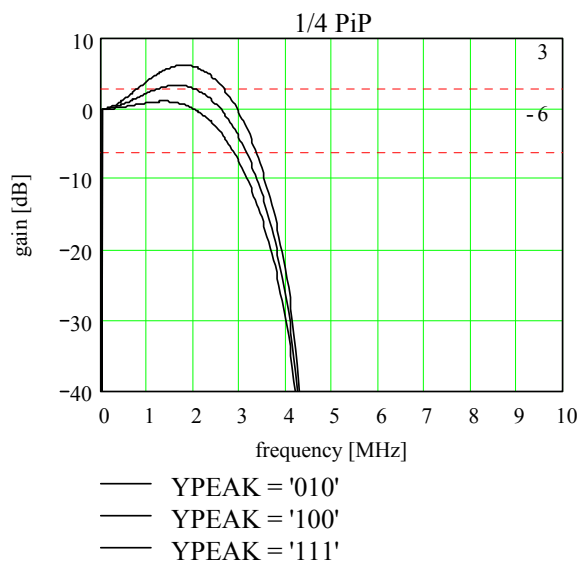


Figure 11-17 Characteristic (PAL) of luminance decimation filter for different peaking factors

Diagrams

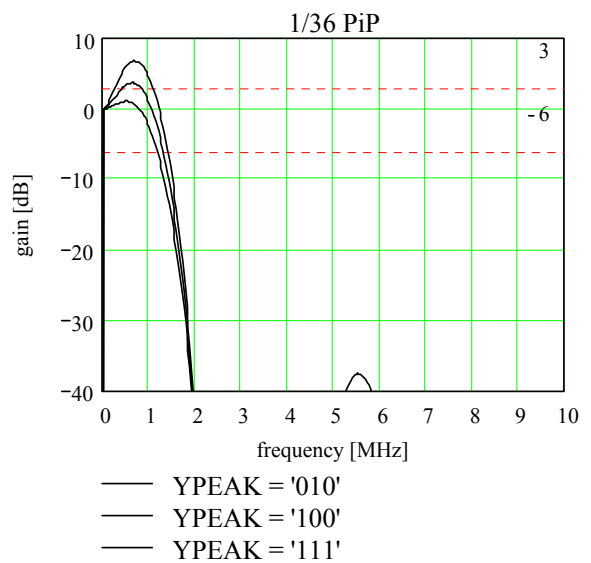
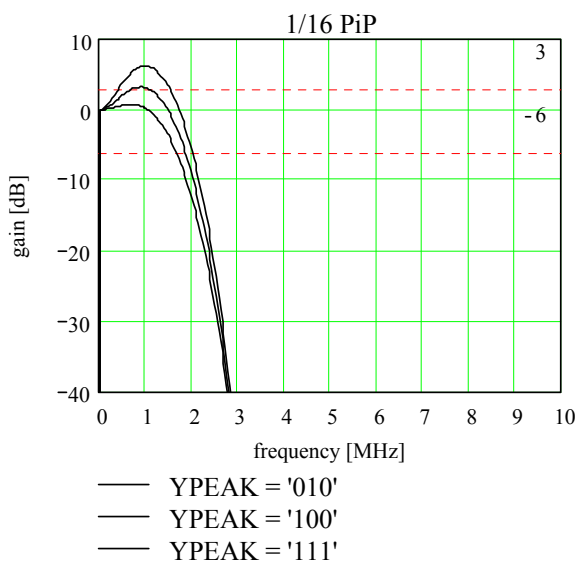
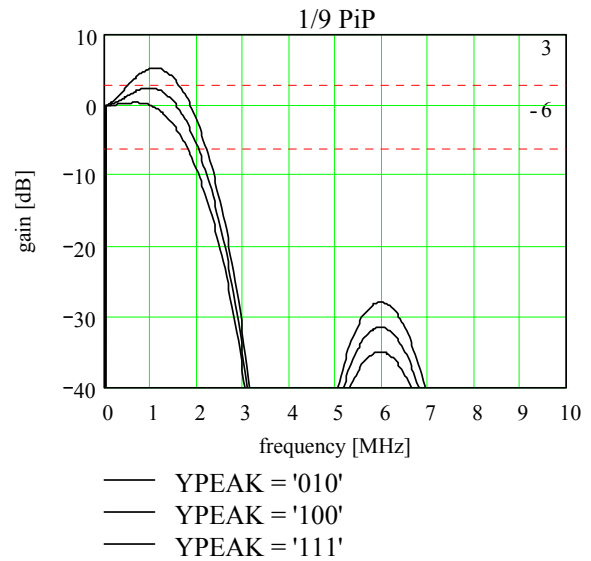
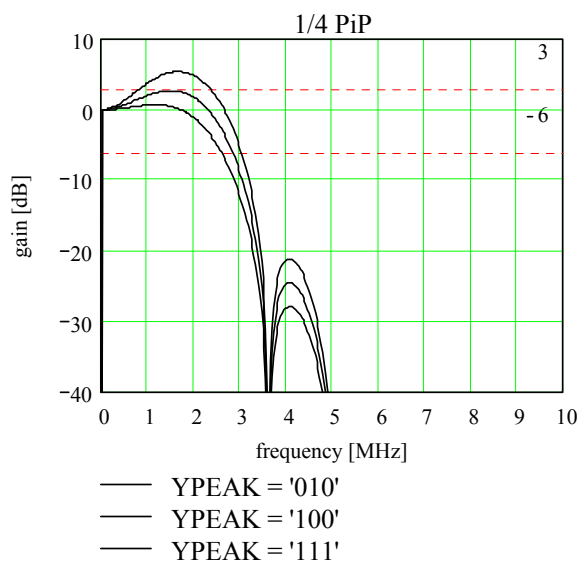


Figure 11-18 Characteristic (NTSC) of luminance decimation filter for different peaking factors

Diagrams

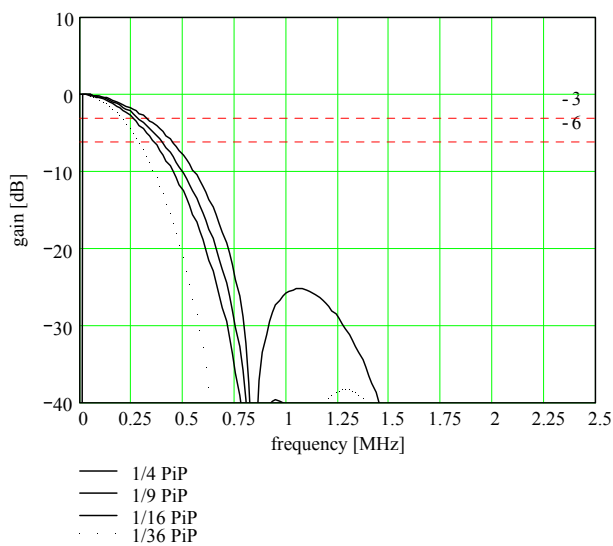
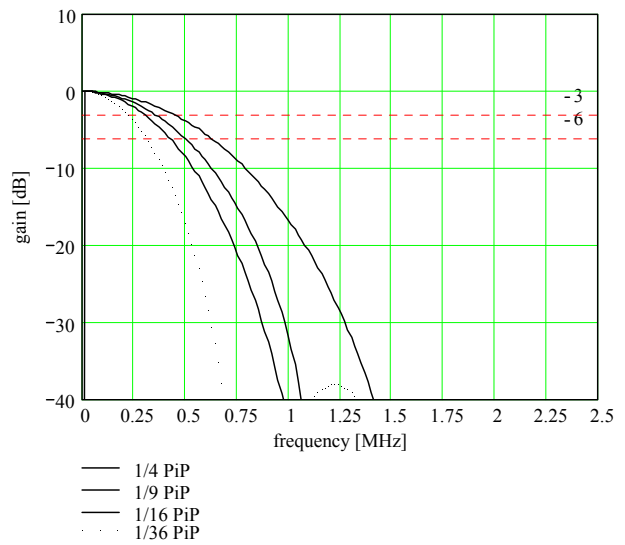
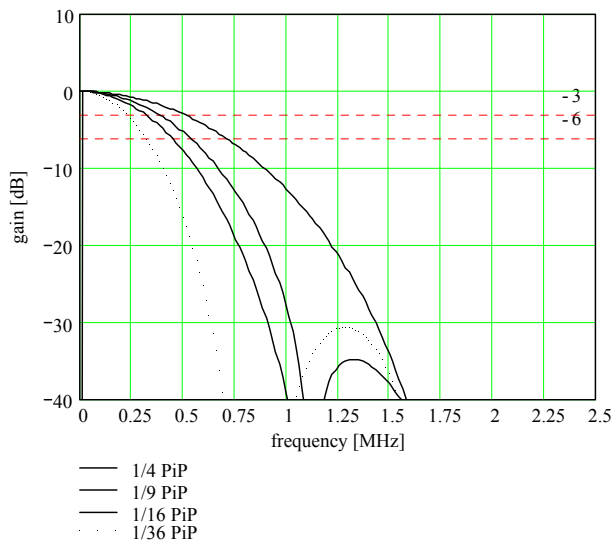
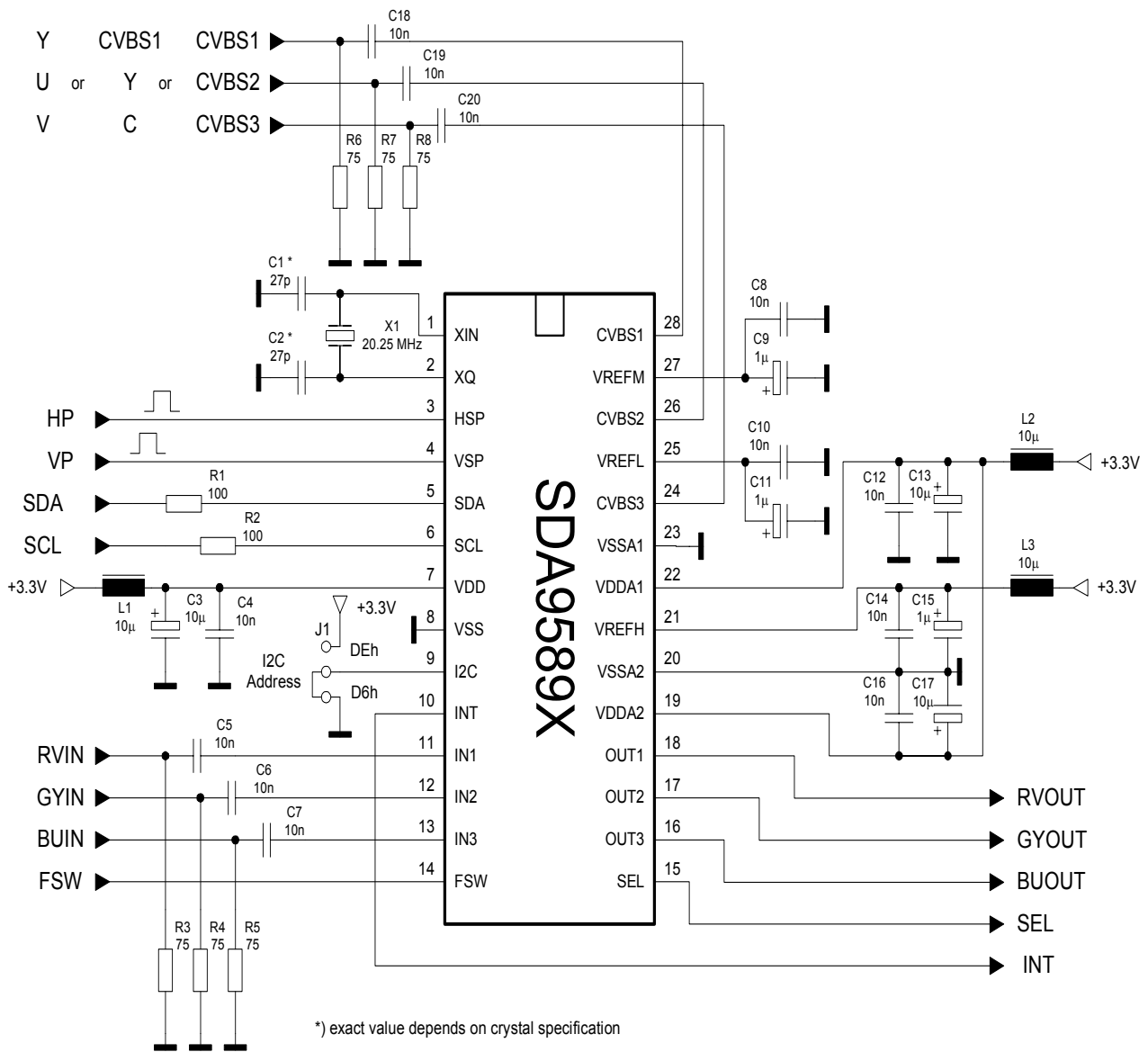


Figure 11-19 Characteristic of chrominance decoder filter (small, medium and narrow)

12 Application Circuit



Micronas GmbH
Hans-Bunte-Strasse 19
D-79108 Freiburg (Germany)
P.O. Box 840
D-79008 Freiburg (Germany)
Tel. +49-761-517-0
Fax +49-761-517-2174
E-mail: docservice@micronas.com
Internet: www.micronas.com

Printed in Germany
Order No. 6251-562-1PD

All information and data contained in this data sheet are without any commitment, are not to be considered as an offer for conclusion of a contract, nor shall they be construed as to create any liability. Any new issue of this data sheet invalidates previous issues. Product availability and delivery are exclusively subject to our respective order confirmation form; the same applies to orders based on development samples delivered. By this publication, Micronas GmbH does not assume responsibility for patent infringements or other rights of third parties which may result from its use.

Further, Micronas GmbH reserves the right to revise this publication and to make changes to its content, at any time, without obligation to notify any person or entity of such revisions or changes.

No part of this publication may be reproduced, photocopied, stored on a retrieval system, or transmitted without the express written consent of Micronas GmbH.